



Instruction Manual

Spa Tables MLW F1 Series



MLW F1 WOOD



MLW F1 SOFT

Fig. similar: colour, decor and finish may vary depending on the model.

Gharieni Group GmbH
Gutenbergstraße 40
47443 Moers / Germany

➤ Phone:	+49 (0)2841/88300-0
➤ Fax:	+49 (0)2841/88300-999
➤ Distribution department:	+49 (0)2841/88300-300
➤ E-mail:	service@gharieni.com
➤ Web:	www.gharieni.com

You can note the **SERIAL NUMBER** here.
The serial number of the MLW is on the rating
plate (s. chapter 7. RATING PLATE).



Preface

Dear customer,

we would like to take this opportunity to thank you for purchasing our quality product and for the trust you have placed in us.

Read the complete IM before using the MLW F1 series for the first time.

Reading the complete IM is essential for the proper and safe use of the MLW F1 series and will help you to operate the appliance to your complete satisfaction.

Our spa tables of the MLW F1 series is very robust and has a long lifespan when used properly.

Read all instructions very carefully and operate the appliance exclusively in accordance with its intended use as described.

This is the only way to protect your customers and yourself from dangers that result from improper use.

Always keep the operating instructions within easy reach of the spa tables of the MLW F1 series.

THIS MANUAL MUST ALWAYS BE ACCESSIBLE TO ANY PERSON OPERATING THE MLW F1; MAKE SURE THAT THE MANUAL HAS BEEN READ AND UNDERSTOOD BEFORE OPERATING THE SPA TABLE.

 WARNING! Non-compliance with the instructions in this manual endangers the life and health of the product operator and / or may damage the spa tables of the MLW F1 series.

Index

1. Safety information.....	5
1.1 Abbreviations	5
1.2 Signal words	6
1.3 Safety instructions.....	6
2. Intended use.....	11
3. Scope of delivery	11
4. Preliminary remarks	11
5. Delivery and unpacking of the MLW	12
5.1 Delivery.....	12
5.2 Unpacking.....	12
6. Assembly and transport of the MLW	14
6.1 Assembly.....	14
6.2 Transport.....	14
6.2.1 Use of the carrying aids	15
6.2.2 Extendable / retractable castors	19
7. Rating plate.....	21
8. QR-Code.....	23
9. Upholstery	27
10. Operation	28
10.1 Characteristics	28
10.2 Model versions	29
10.2.1 MLW F1 / with 4 actuators / Widths: Small, Medium, Large	29
10.2.2 MLW F1 / with 6 actuators / Widths: Medium, Large.....	30
10.3 Before first use	30
10.4 View (Example: MLW F1 Wood).....	31
10.5 Gas springs.....	33
10.6 Headrest	33
10.7 Armrests	35
10.7.1 Pneumatically adjustable armrests	36
10.7.2 Electrically adjustable armrests (optional equipment)	37
10.8 Legrest	38
10.9 Backrest	38
11. Electrical adjustments	38

11.1 Hand Control	38
11.1.2 Memory functions of the hand control	42
11.2 Adjustment of the working height	43
11.3 Adjustment of the backrest.....	43
11.4 Adjustment of the inclination of the seat area	44
11.5 Adjustment of the legrest	44
12. Foot Control.....	45
13. Infrared remote control	47
13.1 Operation	48
14. Smart Thermo heating system (optional equipment).....	50
14.1 Operation	52
15. Audio Relax Headrest (optional equipment).....	57
16. Vibro Wellness 10 (optional equipment)	58
16.1 Hand Control	58
16.2 Operation	60
17. Triple Airback (optional equipment)	63
17.1 Scope of delivery	63
17.2 Characteristics	63
17.3 Control panel.....	64
17.4 Operation	65
18. Multimedia Sound System (optional equipment).....	66
18.1 Abbreviation	66
18.2 Safety information.....	66
18.3 Control panel.....	67
18.4 Compatibility	68
18.5 Playback of music / iPhone, Bluetooth, USB, AUX	69
18.6 Trouble shooting	71
19. Initialization of the software	73
20. Reset.....	74
21. Cleaning and maintenance	75
21.1 Cleaning and care of the upholstery	76
21.1.1 Cleaning and care of the polyurethane (PU) material.....	76
21.2 Cleaning of the housing and the fittings	76
21.3 Cover of the upholstery.....	76
22. Malfunctions (possible causes and troubleshooting)	77

22.1. Repair	78
23. Optionally available accessories.....	79
23.1 Gel cushions for nose slots.....	79
23.2 Towels for nose slots (disposable cloths).....	80
17.3 Neckrest “Dentalax”	80
23.4 Protective covers.....	81
23.4.1 Protective covers made of terry.....	81
23.4.2 Protective covers made of PU	82
23.4.3 Protective foot cover.....	82
24. Upholstery care and cleaning agents	84
24.1 mikrozid [®] sensitive (alcohol-free)	84
24.2 Skai cleaner.....	86
25. Conditions for transport, storage, and operation	87
25.1 Transport (with castors / without castors).....	87
25.2 Ambient conditions for storage and transport	87
25.3 Ambient conditions for operation.....	87
26. Technical Data	88
27. Disposal	90
28. Warranty provisions	91
28.1 Warranty exclusions	91
29. EC-Declaration Of Conformity	92
30. Status of edition	93



Do not dispose of the MLW together with your domestic waste.
The Spa Table must be disposed of at a collecting centre for recyclable
electric and electronic appliances.
Do not remove the symbol from the MLW.

1. Safety information

When using electrical products / appliances, especially when children are present, basic safety precautions should always be followed, including the following:

READ THE COMPLETE SAFETY INFORMATION AND SAFETY INSTRUCTIONS CAREFULLY BEFORE YOU OPERATE THE MLW FOR THE FIRST TIME.

- **All information included in those pages serve for the protection of the operator. If you ignore the safety information and safety instructions, you will endanger your health and life and as the health and life of your clients.**
- **MAKE SURE THAT THIS MANUAL IS AVAILABLE TO ANYONE USING THE GHARIENI SPA TABLE MLW NEO AND MAKE SURE THAT IT HAS BEEN READ AND UNDERSTOOD PRIOR TO USING THE SPA TABLE.**
- This instruction manual is an integral part of the product and must be carefully kept in a safe place to consult it throughout the equipment service life. Copies of this instruction manual are available upon request.
- The Gharieni Group GmbH shall not be held responsible for any damages, direct or indirect, caused to persons, animals or objects resulting from negligence or non-compliance with the instructions contained in this instruction manual.
- Before you dispose of a Spa Table or any old appliance, **render it inoperative.** Unplug the Spa Table / appliance and cut off the entire power cord. Dispose of the power cord and the plug immediately.

★ Store this manual in a safe place so you can use it whenever it is needed. Strictly observe the instructions to avoid damage to persons and property.

1.1 Abbreviations

MLW F1 / MLW	➤ GHARIENI SPA TABLES OF THE MLW F1 SERIES (MLW F1 WOOD / MLW F1 SOFT)
SMART THERMO	➤ SMART THERMO HEATING SYSTEM
	➤ OPERATING ADVICE / TIP

1.2 Signal words

⚠ DANGER! indicates a hazardous situation which, if ignored, will result in death or serious injury.

⚠ CAUTION! indicates a hazardous situation which, if not avoided, may result in minor or moderate injury.

⚠ WARNING! indicates a hazardous situation which, if ignored, could result in death or serious injury.

NOTICE! indicates a hazardous situation which, if ignored, may result in damage to the spa table / appliance.

1.3 Safety instructions

⚠ DANGER!

To reduce the risk of electrocution:

1. Non-compliance of the orders of this instruction manual will endanger the life and health of the operator and / or can result in damages to the Spa Table.
2. All electrical work to connect the MLW to the mains must be carried out by a qualified professional. Do not modify the energy supply. The connection must be carried out in accordance with the current local and legal regulations. **RISK OF ELECTRIC SHOCK!**
3. The technical data of your energy supplier **must** meet the data on the rating plate of the MLW.
4. Do not make any changes or manipulations to the 601 and / or its power supply (mains cable, mains plug). In case of unauthorised changes or manipulations, **any** warranty of the manufacturer is excluded.
5. **Do not connect** the MLW to the mains if the Spa Table itself or the power cable or the plug are visibly damaged. **RISK OF ELECTRIC SHOCK!**
6. The power supply cable shall not be placed below the MLW, except it is expressly permitted by the manufacturer. **RISK OF ELECTRIC SHOCK!**
7. The power cord must not be placed close to the actuators during connection or repositioning as it can be damaged while operating the actuators. **RISK OF ELECTRIC SHOCK!**
8. Never roll the MLW over the power cord; otherwise you can damage the power cord permanently.

9. When retracting the castors, the power cord must not be under the MLW; otherwise, the adjustable feet may squeeze the power cord and cause permanent damage. RISK OF ELECTRIC SHOCK!
10. Never try to repair the MLW yourself. If the MLW does not operate properly, please contact the manufacturer or the shop you purchased the MLW at. Original spare parts should be used only.
11. If the power cable and / or the plug are damaged, it **must** be replaced by the manufacturer or an authorized aftersales service or a qualified professional only. **Never** try to repair or replace the power cable and / or the plug yourself. RISK OF ELECTRIC SHOCK!
12. **Always** unplug the MLW if it is not used for a longer period.
13. Always disconnect the MLW from the mains before cleaning and / or maintenance. RIKS OF ELECTRIC SHOCK!
14. **Never** pull the power supply cable to unplug the MLW. Always use the power plug itself to unplug the MLW. RISK OF ELECTRIC SHOCK!
15. **Never** touch the power plug, the power switch, or other electrical components with wet or damp hands. RISK OF ELECTRIC SHOCK!
16. Do not place or store the MLW close to a bath, a shower, or a washbasin. There is danger that the MLW may meet splashed water. RISK OF ELECTRIC SHOCK!
17. If you have selected the multimedia sound system option, please also be sure to observe the separate safety information and safety instructions for this option; chapter 18. MULTIMEDIA SOUND SYSTEM (optional equipment) and seq.

 **WARNING!**

To reduce the risk of burns, electrocution, fire, or injury to persons:

1. Use a properly grounded socket with the appropriate voltage (230 V AC) only.
2. **The electric components must not meet water or other liquids.** RISK OF ELECTRIC SHOCK!
3. Check all cables regularly and contact our Customer Service Department if any cable is in improper condition. RISK OF ELECTRIC SHOCK!
4. The MLW must not stand on the power cord. Ensure that the cord is not damaged when moving the MLW. Do not step on the cord. Do not stretch the cord.
5. Always ensure that the power cord is not bent or squeezed during installation.

6. **Do not** use any extension cords, multiple sockets, or adapters.
RISK OF FIRE!
7. **Do not** open the housings of the electric control panels! RISK OF ELECTRIC SHOCK!
8. Liquids **must not** get into the electric control panels! RISK OF ELECTRIC SHOCK!
9. Do not use water or any other liquids while carrying out any application. Do not spill water or any other liquids over, on or into the MLW. Should you spill any water, **immediately** pull the mains plug and dry the MLW thoroughly. RISK OF ELECTRIC SHOCK!
10. **Never** immerse any parts of the MLW in water. When cleaning the MLW, make sure that no water penetrates the MLW or its housing. RISK OF ELECTRIC SHOCK!
11. For models with the Smart Thermo heating system and / or the Vibro Wellness 10 function, the cables are located between the upholstery and the base (depending on the model). **The upholstery may only be removed by persons authorised by us.**
12. **For MLW F1 Soft only:** To prevent damage caused by heat, a gap must be left between the backrest and the seat upholstery (see illustration below) when the heating system (optional equipment) is used for longer periods, so that the two heating elements do not touch each other and can add up. RISK OF BURNS DUE TO HEAT ACCUMULATION!



Correct

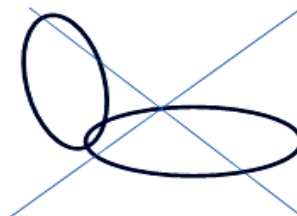

Wrong

13. **People with acute pain, venous disorders, low blood pressure, inflammatory processes and other medical conditions that make heat applications or this form of client positioning questionable must always consult a doctor before use.**
14. **Never use the 601 on people who are under the influence of alcohol or drugs.**
15. Operate or store the MLW in a dry environment **only**.
16. Close supervision is necessary when the MLW is used by, on, or near children or invalids.
17. Use the MLW only for its intended use as described in this manual. Do not use attachments / accessories not recommended by the manufacturer.

18. Never operate the MLW if it has a damaged cord or plug, if it is not working properly, if it has been damaged or if it has become wet. Return the MLW to an authorized aftersales service for examination and repair.
19. Remove possible dust accumulation at the power plug, at the safety power socket and at all plug connectors **regularly**.
RISK OF FIRE!
20. Keep the cord away from heated surfaces.
21. Never drop or insert any object into any opening.
22. Do not use the MLW outdoors.
23. Do not allow any unauthorized person to operate the MLW!
24. Use the MLW only on a level surface.
25. **Do not place** any objects or liquids on the MLW. The Spa Table as well as the material can be damaged thereby. RISK OF ELECTRIC SHOCK! RISK OF DAMAGE!
26. Any repairs and maintenance work must be carried out by qualified professionals authorized by the Gharieni Group GmbH **only**!
RISK OF ELECTRIC SHOCK! RISK OF FIRE!
27. **Do not use** a steam cleaner for cleaning. RISK OF ELECTRIC SHOCK!
28. **Never** rest or stand on any part of the lying surface or of the supporting structure of the MLW. Do not exert strong physical forces on these components; otherwise you can damage the supporting structure permanently. RISK OF TIPPING! RISK OF BREAKAGE! RISK OF INJURY!
29. Persons, animals or body parts of persons and animals **must not** be positioned between the base and the upper structure. RISK OF CRUSHING!
30. Ensure that no parts of the body or items are between the parts of the MLW while adjusting the lying position. RISK OF CRUSHING!
31. **Do not** use the supporting structure as a footrest. RISK OF CRUSHING!
32. Always ensure that the MLW stands on its solid adjustable feet. If the MLW stands on its mobile castors only, there is a RISK OF ROLLING AWAY!
33. **Never** extend the castors while any person is on the MLW. Do not move the MLW on its castors if any person or load is on the MLW; otherwise you damage the substructure or castors.
34. The MLW must **never** be used (neither with nor without castors) for to transport persons or heavy loads. RISK OF INJURY! RISK OF DAMAGE!
35. While unpacking, the packaging materials (polyethylene bags, polystyrene pieces, etc.) should be kept away from children and pets. RISK OF INJURY! CHOKING HAZARD!

36. Always keep children and pets away from the MLW.
37. Children must not play with the MLW or its single components.
38. The MLW is not intended to be operated by persons with reduced physical, sensory, and mental capabilities or lack of experience or knowledge, unless they are supervised or instructed concerning the use of the MLW and do understand the danger resulting thereof.

NOTICE!

1. The special pallet the MLW is delivered on has cut-outs. Upon delivery, the adjustable feet of the MLW stand in the respective cut-outs to prevent the Spa Table from inadvertent movement. Therefore, **it is essential to lift the MLW vertically off the special pallet using all four special carrying aids**. Non-compliance with this instruction can damage the adjustable feet of the MLW seriously. RISK OF DAMAGE!
2. For safety reasons, the MLW moves only while pressing a button of the hand controls or the optional foot control. When you stop pressing, all moving operation will stop immediately.
3. **Never** rest, stand, or kneel on any part of the lying surface of the MLW. Do not exert strong physical forces on the lying surface; otherwise you can damage the upholstery permanently. RISK OF DAMAGE!
4. Do not lean, stand, or sit on the armrests or headrest; otherwise you can damage the armrests or headrest permanently! RISK OF DAMAGE!
5. The maximum load capacity of the armrests is 25 kg.
6. The rating plate must not be removed or made illegible.
Non-compliance will expire the warranty!

READ THESE INSTRUCTIONS THOROUGHLY
AND KEEP THEM SAFE.

2. Intended use

- ❖ Read the instructions very carefully and **only** operate the Spa Table in its intended use as described to protect you and your customers from danger.
- ❖ The MLW is a versatile Spa Table. You can use it for e.g. cosmetic applications or full body massages in dry rooms, etc.
Any other use is not permitted and will affect the warranty claims.
- ❖ The Gharieni Spa Table MLW is not a medical device relevant to the medical devices act.
- ❖ The MLW is intended for indoor use **only**.

★ **No liability for personal injury or material damage will be accepted if these instructions are not followed.**

3. Scope of delivery

- 1 SPA TABLE MLW F1 WOOD / MLW F1 SOFT in desired design and equipment incl. rating plate and QR-Code.
 - 1 HAND CONTROL
 - 4 CARRYING AIDS
 - 1 INSTRUCTION MANUAL
- i** If you have purchased additional optional accessories for your Spa Table, these are also included in the scope of delivery.

4. Preliminary remarks

- ❖ The Gharieni Spa Table MLW is subject to the highest safety and quality standards.
- ❖ Before initial operation, make sure that all parts are present and show no visible damage.
- ❖ Make sure that the socket for the MLW is properly grounded and has the correct voltage rating.



Before assembly, ensure that sufficient space is provided for the MLW so that it does not bump into anything even when fully extended.

5. Delivery and unpacking of the MLW

5.1 Delivery

- ❖ The MLW is delivered and packed in a cardboard on a special pallet (s. fig. below). The MLW is in complete horizontal position and the upholstery is installed.



DELIVERY BY GHARIENI GROUP GMBH:

If the MLW is delivered by Gharieni Group GmbH, the driver will **help** with the installation of the MLW and will also dispose of the packaging material and the special pallet.

DELIVERY BY AN EXTERNAL FORWARDER:

If the MLW is delivered by an external forwarder, the MLW is normally **only** delivered. In this case, you must dispose of the packaging material and the special pallet on your own responsibility.

5.2 Unpacking

⚠ WARNING! While unpacking, the packaging materials (polyethylene bags, polystyrene pieces, etc.) should be kept away from children and pets. **RISK OF INJURY! CHOKING HAZARD!**

- ❖ The MLW is delivered and packed in a cardboard on a special pallet (s. fig. below).

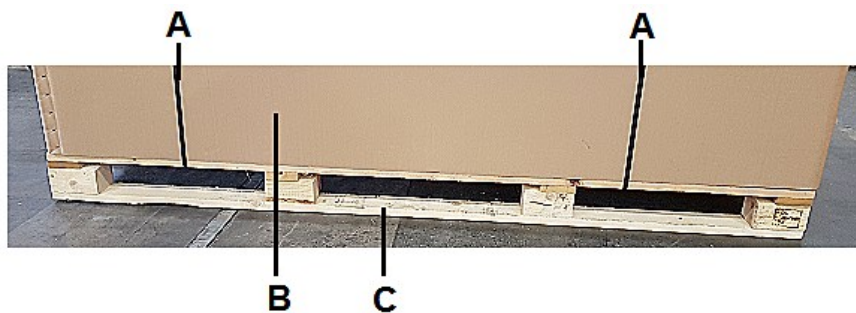
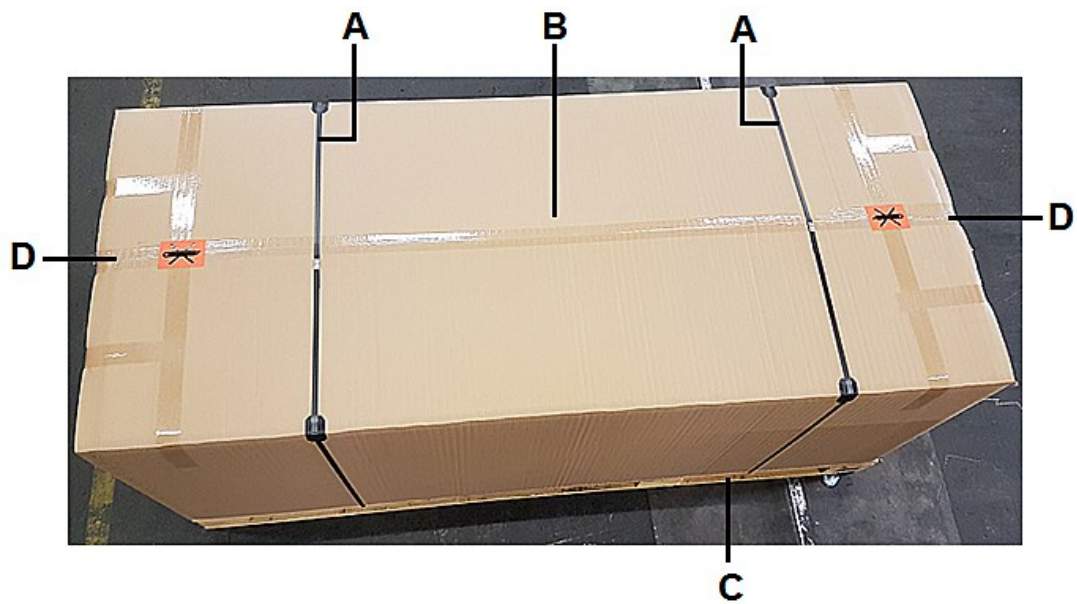

A	PACKAGING TAPES
B	UPPER CARDBOARD
C	SPECIAL PALLET
D	SHORT SIDES OF THE CARDBOARD

1. Cut the packaging tapes (**A**) with scissors and remove them.
2. **DO NOT open** the upper cardboard (**B**) **but** lift it carefully and vertically as a whole from the MLW and from the special pallet (**C**). For this purpose, you will need two persons (one person each on the short sides / **D** of the cardboard).
3. Dispose of the cardboard properly.
4. Now you can move the MLW from the special pallet; **strictly observe** the instructions given in chapter 6.2 TRANSPORT / CARRYING AIDS and chapter 6.2.1 USE OF THE CARRYING AIDS when doing so.

6. Assembly and transport of the MLW

6.1 Assembly

The MLW is usually delivered fully assembled, so no assembly work is necessary. In **exceptional cases**, necessary assembly work will be carried out by the deliverer on site.

- i** Before installation, ensure that there is sufficient free space for the MLW relevant to its total length.

⚠ WARNING! For models with the Smart Thermo heating system and / or the 10 Vibro Wellness function, the cables are located between the upholstery and the base (depending on the model). **The upholstery may only be removed by persons authorised by us.**

6.2 Transport

- i** A transport of the MLW can be severely affected to some extent due to unfavourable environment conditions. Such unfavourable environmental conditions are e.g. narrow doors, narrow corners behind doors, narrow corridors, narrow staircases, spiral staircases etc. The weight of the MLW is at least 125 kg; the length is approx. 203 cm and the width including the upholstery is 76 cm / 85 cm or 92 cm¹; thus, the manoeuvrability of the MLW is limited.

EXTENDABLE / RETRACTABLE CASTORS:

- ❖ The MLW is equipped with extendable / retractable castors. The castors can be extended to change the site of the MLW (s. chapter 6.2.2 EXTENDABLE / RETRACTABLE CASTORS).
- i** If the floor conditions are not ideal, e.g. a wavy, uneven floor or a tiled floor with wide and deep joints, the MLW must not be moved on the extendable castors, otherwise it can be seriously damaged. In this case, you must use the CARRYING AIDS supplied (s. fig. below).

¹ Small / Medium / Large



(Fig. similar: Fig serves as an example only)

CARRYING AIDS:

- i** You **also** need the carrying aids (s. fig. above) **to lift the MLW off the special pallet**. The proper use of the carrying aids is described below in chapter 6.2.1.
- i** You need **4 persons** to move or transport the MLW using the carrying aids.

6.2.1 Use of the carrying aids

⚠ DANGER! After transport, while putting down the MLW, the power cord must not be under the Spa Table; otherwise the adjustable feet may squeeze the power cord and cause permanent damage while putting down the MLW or when retracting the castors.

⚠ WARNING! RISK OF CRUSHING your toes / feet while lowering or moving the MLW.

NOTICE! The special pallet the MLW is delivered on has recesses. Upon delivery, the adjustable feet of the MLW stand in the respective recesses to prevent the Spa Table from slipping. **Therefore, it is essential to lift the MLW vertically off the special pallet** using all four carrying aids. Non-compliance with this instruction can seriously damage the adjustable feet of the MLW. RISK OF DAMAGE!



i Figures similar: All following figures serve as examples only.

1. To move the MLW from the special pallet, you must raise it first. Plug in the MLW to do this. Then press the corresponding button of the hand control which is on one side on a suspension mechanism / **button T 1**, s. fig. in chapter 11.1 HAND CONTROL.



2. You must set the backrest in upright position before you use the special carrying aids. To do this, press the corresponding push button of the hand control (**button A**, s. fig. in chapter 11.1 HAND CONTROL).
3. **Then unplug the MLW again.**
4. Lift the lower casing (**A**) by hand (s. fig. below) at the head and foot ends simultaneously by hand until the opening for the carrying aids become visible. You need to persons for this (one person at the head end and one person and the foot end of the spa table).



A

LOWER CASING

NOTICE! You must **always** lift the casing of the spa table with one person at the head end and one person at the foot end **at the same time**, otherwise you can seriously damage the spa table.
RISK OF DAMAGE!

- Two more people can now insert the carrying aids (C) into the openings (B) provided for them in the feet (2 carrying aids at the head end / 2 carrying aids at the foot end of the spa table); s. fig. below.

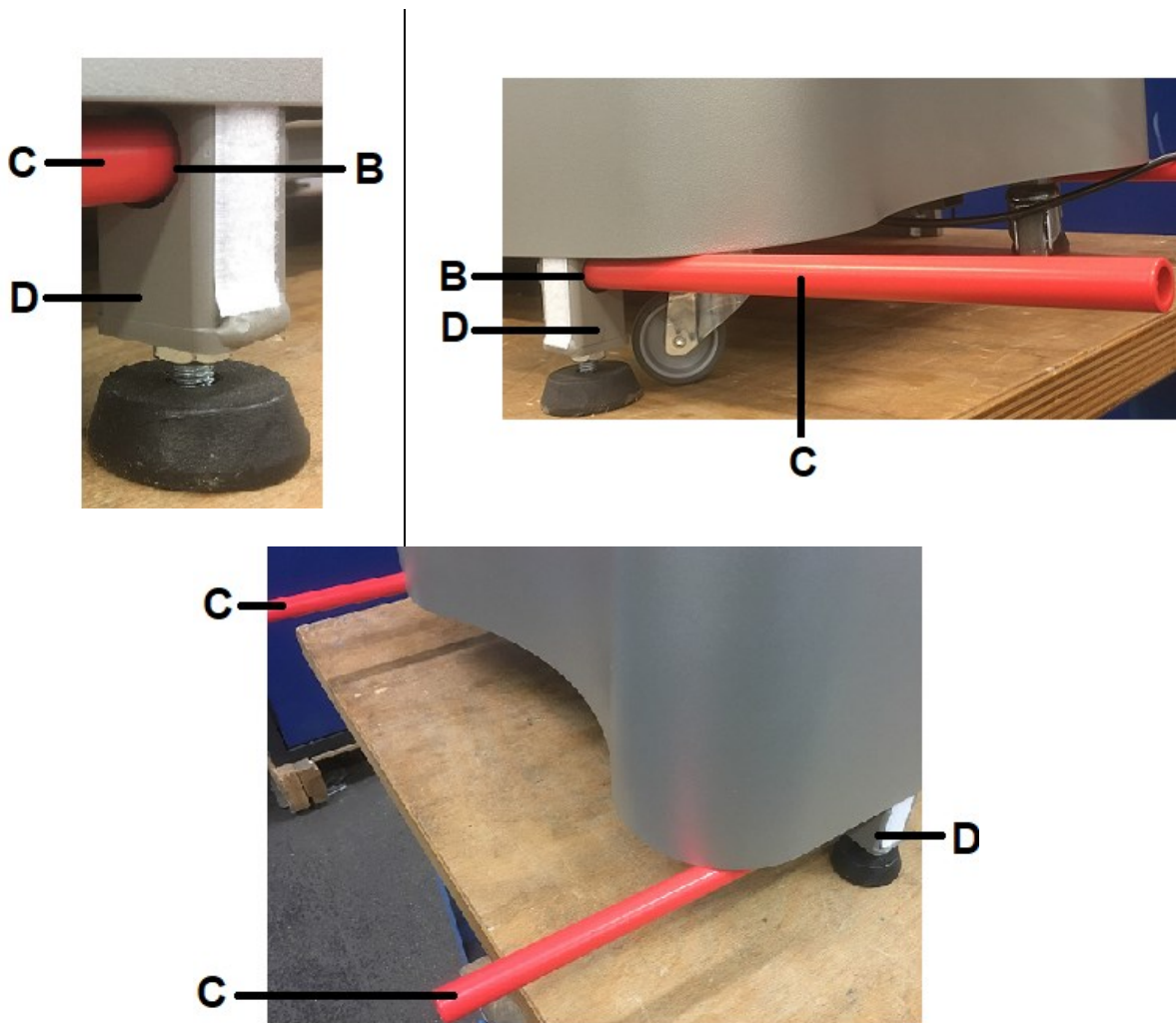

B	OPENINGS PROVIDED FOR THE CARRYING AIDS
C	CARRYING AIDS
D	FOOT

- You also need **four persons** to carry the MLW to the area you want.
- Make sure to lift the MLW (using **all four** carrying aids) **vertically** off the special pallet. Otherwise you will damage the feet.

8. **Only** carry the MLW using **all four** carrying aids; otherwise you may damage the MLW irreparably.
9. Keep the carrying aids in a safe place. If the MLW needs to be carried later (e.g. when moving to a new house), this can only be done using the carrying aids.
10. If the floor is not completely level, you must ensure the stability of the MLW by adjusting the four feet (**D**), s. fig. below.
After adjusting the feet, secure them by tightening the respective lock nut (**E**), s. fig. below.

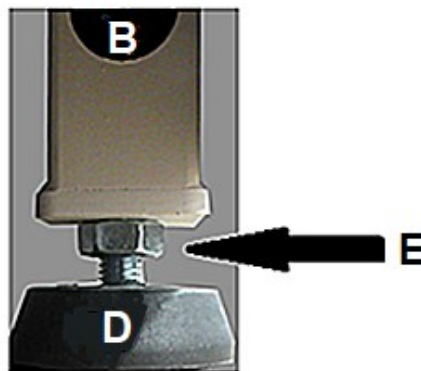

B	OPENING PROVIDED FOR THE CARRYING AIDS
D	ADJUSTABLE FOOT
E	LOCK NUT

NOTICE! Once you have found a suitable place with enough space for the spa table, remove the carrying aids and store them well for possible later transport!

NOTICE! If the floor is not completely level, you must ensure the stability of the MLW by adjusting the four feet.

6.2.2 Extendable / retractable castors

⚠ DANGER! When retracting the castors, the power cord must not be under the MLW; otherwise, the adjustable feet may squeeze the power cord and cause permanent damage. RISK OF ELECTRIC SHOCK!

⚠ DANGER! Never roll the MLW over the power cord; otherwise you can damage the power cord permanently.

⚠ WARNING! Always ensure that the MLW stands on its solid adjustable feet. If the MLW stands on its adjustable castors only, there is a RISK OF ROLLING AWAY!

⚠ WARNING! RISK OF CRUSHING your toes / feet while lowering or moving the MLW.

⚠ WARNING! **Never** extend the castors while any person is on the MLW.

⚠ WARNING! **Do not** move the MLW on its castors if there are persons or loads on the MLW; otherwise you will damage the construction / substructure of the MLW as well as its castors. RISK OF INJURY! RISK OF DAMAGE!

⚠ WARNING! The MLW **must never** be used (neither with nor without castors) for carrying or transporting persons or heavy loads. RISK OF INJURY! RISK OF DAMAGE!

USE OF THE MECHANICALLY EXTENDABLE CASTORS:

- ❖ The lever to mechanically extend the castors is located inside the housing at the foot end of the spa table below the legrest.
- 1. To gain access to the lever, you must raise the legrest (**A**), **button D** of the hand control / s. fig. in chapter 11.1 HAND CONTROL and see also chapter 11.5 ADJUSTMENT OF THE LEGREST.
- i** In addition, extend the inclination of the seat area (**button C**, s.fig. in chapter 11.1 HAND CONTROL) to gain even better access to the lever.

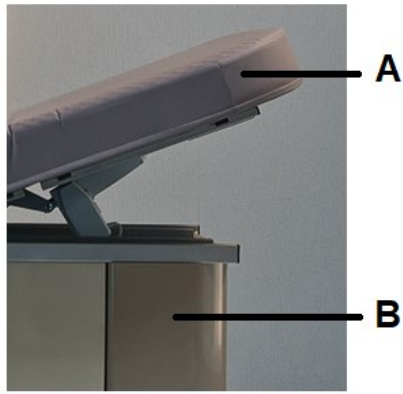

A	LEGREST
B	(HOUSING) Foot end of the MLW

2. At the bottom of the now open housing (B) is the lever (C) for mechanical extension of the castors; s. fig. below.

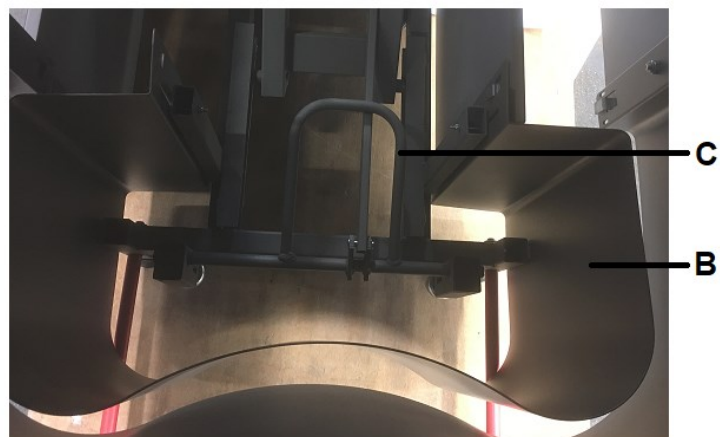
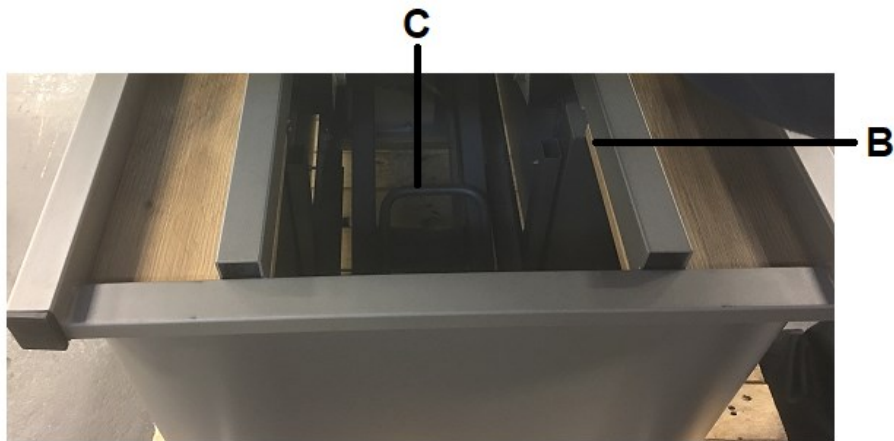

B	HOUSING / FOOT END (view from above in the housing)
C	LEVER for operation of the extendable / retractable castors

3. Pull the lever (**B**) **towards you** to extend the castors.
You must overcome an obstruction point.
4. The castors are now extended.
- i** **Before moving the MLW**, roll up the power cord properly and store it so that it cannot be rolled over when moving the MLW. Do not retract the castors until the MLW is in the desired area and you have ensured that the power cord is not under the MLW or under the feet.
5. Now you can roll the MLW to another position.
Be careful not to damage the power cord!
6. Proceed in reverse order to retract the castors.

7. Rating plate

- i** The rating plate is in the housing at the head end of the MLW:
on the construction below the headrest and backrest.
1. To gain access to the RATING PLATE, you must place the backrest in an upright position (s. fig. below / **button B** of the hand control, s. fig. in chapter 11.1 HAND CONTROL).



2. The RATING PLATE is on the construction (s. fig. below).



A

RATING PLATE

- i** The first item on the RATING PLATE is the serial number.
- i** **The rating plate must never be removed or made illegible!
Non-compliance will lead to exclusion from warranty!**



If you wish to contact the Gharieni customer service regarding your Spa Table, we recommend taking a photo of the rating plate previously (e.g. using a mobile phone or a digital camera). This makes it easier for you to identify the information of the rating plate (e.g. the serial number of the Spa Table) to provide the required information to the customer service. On the cover page of this instruction manual is an empty field in which you can enter the serial number of your Spa Table. This way you have the serial number always at hand.

8. QR-Code



In case of service, you can scan the QR code using the OCR scan function of a suitable device (e.g. a smartphone).

A form will then open via the Internet browser of your device, which already automatically contains the serial number of your MLW. Please describe your problem there and enter your data. You can attach a file from your device memory or take a photo with your device and attach it. To do this, tap on the "Select file" button. A window with options will then open. The appearance of this window may differ from the illustration, depending on your device and operating system.

After you have confirmed that you have read our data protection guidelines by marking the box at the end of the form, the form with all the entries you have made is immediately sent to our customer service department by clicking on "Send".

- ❖ The QR code is located on the head side of the MLW: on the construction below the headrest and backrest.

- i** To gain access to the QR-CODE, you must place the backrest in an upright position (s. fig. below / **button B** of the hand control / s. fig. in chapter 11.1 HAND CONTROL).



B

B

QR-CODE

(Figure similar, position might differ)

Serial number (Complete as written on nameplate) /
Seriennummer (Komplett wie im Typenschild) /
Numéro de série (Complet comme inscrit sur la plaque d'identification)

KoM4-3A-M1-SUPERSOFT-SM-RAL9007-0530

Please describe the issue* (Required Field) /
Bitte schildern Sie das Problem * (Pflichtfeld) /
Veuillez s'il vous plait décrire le problème* (Champ obligatoire)

Add file: / Datei hinzufügen: / Ajoutez un fichier:

Datei auswählen Keine ausgewählt

Your address / Ihre Adresse / Votre adresse

First and last name* (Required Field) /
Vor- und Zuname * (Pflichtfeld) /
Prénom et nom* (Champ obligatoire)

Company / Firma / Entreprise

Street adress /
Strasse und Hausnummer /
Rue et numéro de rue

ZIP Code* (Required Field) /
Postleitzahl* (Pflichtfeld) /

Figure shows form that opens in the Internet browser of the device after the QR code is scanned.

Code postal* (Champ obligatoire)

City* (Required Field) /
Stadt* (Pflichtfeld) /
Ville* (Champ obligatoire)

E-Mail-Adress* (Required Field) /
E-Mail-Adresse* (Pflichtfeld) /
Votre adresse e-mail* (Champ obligatoire)

Phone number* (Required Field) /
Telefonnummer* (Pflichtfeld) /
Téléphone* (Champ obligatoire)

I read the privacy policy of the Gharieni Group.
Ich habe die [Datenschutzrichtlinien](#) der Gharieni Group gelesen.< /br> J'ai lu la [protection des données](#) du Groupe Gharieni.

SEND

Figure shows form that opens in the Internet browser of the device after the QR code is scanned.

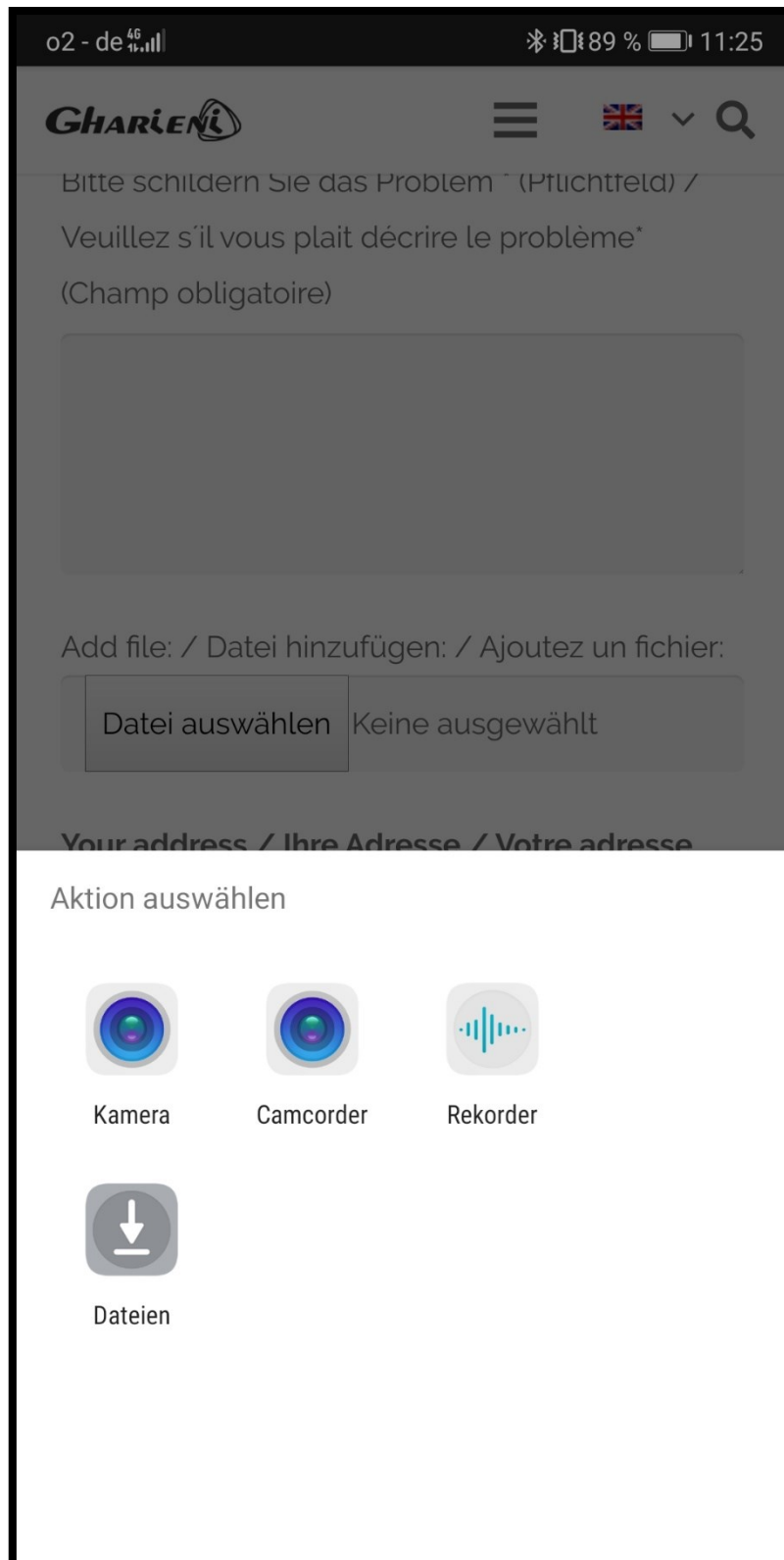

*Figure similar: option window for adding a file.
Appearance may vary depending on the device and operating system.*

9. Upholstery

- ❖ The MLW is available in **two** upholstery variants (MLW F1 Wood = standard upholstery / MLW F1 Soft = soft upholstery; s. below).
- ❖ The upholstery of the MLW F1 is available with an outer material made of polyurethane (PU).

STANDARD UPHOLSTERY WITH A POLYURETHANE (PU) SURFACE:

- ❖ The **MLW F1 Wood** is equipped with a soft, comfortable, and high quality one-piece upholstery (s. fig. below).
- ❖ The inner material of the upholstery is made of high quality foam.
- ❖ The outer material is made of **polyurethane (PU)** and is available in different colours.
- ❖ This material (PU) is elastic and easy to clean.
It is waterproof, oil-repellent, and washable up to 90 °C.



Fig. similar: colour and design may vary depending on the model.

SOFT UPHOLSTERY WITH A POLYURETHANE (PU) SURFACE:

- ❖ The **MLW F1 Soft** is equipped with an **extra soft**, comfortable, and high quality one-piece upholstery (s. fig. below).
- ❖ The inner material of the upholstery is made of high quality foam.
- ❖ The outer material is made of **polyurethane (PU)** and is available in different colours.
- ❖ This material (PU) is elastic and easy to clean.
It is waterproof, oil-repellent, and washable up to 90 °C.



Fig. similar: colour and design may vary depending on the model.

10. Operation

⚠ WARNING! Do not sit on the headrest and armrests.

⚠ WARNING! Do not carry out any physical force to the components named before. Non-compliance can cause permanent damage to the construction of the MLW. **RISK OF TIPPING! RISK OF BREAKAGE! RISK OF INJURY!**

10.1 Characteristics

- ❖ The MLW is a versatile Spa Table. You can use it for e.g. cosmetic applications or full body massages in dry rooms.
- ❖ The MLW has a narrow housing (57 cm) and specially curved front sides. These features allow more foot and leg room and thus make it easier for you to work during massages and cosmetic treatment.
- ❖ The MLW F1 is available in two upholstery versions (MLW F1 Wood / MLW F1 Soft); s. chapter 9. UPHOLSTERY.
- ❖ The entry height of the MLW F1 Soft is approx. +5 cm compared to the MLW F1 Wood due to the thicker upholstery.
- ❖ The MLW F1 is also available in different widths (SMALL, MEDIUM, LARGE / s. chapter 10.2 MODEL VERSIONS).
- ❖ The Gharieni MLW F1 is a spa table that can be equipped with up to six actuators (s. chapter 10.2 MODEL VERSIONS), with which you can flexibly adjust the spa table to your wishes via hand control.
- ❖ MODELS WITH FOUR ACTUATORS: Working height, backrest, inclination of the seat area and legrest are electrically adjustable: the inclination of the seat area can be adjusted by the electrically adjustable knee bend (s. chapter 11. ELECTRICAL ADJUSTMENTS).
- ❖ MODELS WITH SIX ACTUATORS: Working height, backrest, inclination of the seat area and the armrests are electrically adjustable (optional equipment).
- ❖ Frequently used treatment positions can be saved by eight freely selectable memory positions on the hand control (s. chapter 11.1.2 MEMORY FUNCTIONS OF THE HAND CONTROL).
- ❖ The armrests can be adjusted and swiveled pneumatically; s. chapter 10.7.1 PNEUMATICALLY ADJUSTABLE ARMRESTS.
- ❖ Electrically adjustable armrests (non-swiveling) are also available as an option for the MLW, s. chapter 10.7.2 ELECTRICALLY ADJUSTABLE ARMRESTS (OPTIONAL EQUIPMENT).
- ❖ The headrest is pneumatically adjustable (s. chapter 10.6 HEADREST).

- ❖ Three adjustment controls are available when purchasing an MLW F1: hand control, remote control, or foot control. Only one of these is included in the delivery; the other two can be purchased at extra charge.
- ❖ The MLW has a wide range of adjustment options and can therefore be used for many applications.
- ❖ The maximum lifting capacity of the mlw is 250 kg.
- ❖ The maximum load capacity of the lying surface is 300 kg.
- ❖ The maximum load capacity of the armrests is 25 kg.

10.2 Model versions

- ❖ The Spa Tables of the Gharieni MLW Neo series are available in three different widths: SMALL 76 CM / MEDIUM 85 CM / LARGE 92 CM.



Fig. similar: colour and design may vary depending on the model.

SMALL	MEDIUM	LARGE
-------	--------	-------

- ❖ The spa tables of the MLW F1 series are optionally equipped with up to six actuators (depending on the desired version), with which you can flexibly adjust the spa table according to your wishes via a hand control.
- ❖ The areas that are **not** actuator-operated in the respective versions (headrest / armrests) can be adjusted pneumatically using a gas spring with a lever.

➤ s. also chapter 11. ELECTRICAL ADJUSTMENTS.

10.2.1 MLW F1 / with 4 actuators / Widths: Small, Medium, Large

MLW F1 (S / M / L) // WITH 4 ACTUATORS	
Actuator 1	Electrical HEIGHT ADJUSTMENT.
Actuator 2	BACKREST electrically adjustable.
Actuator 3	INCLINATION OF THE SEAT AREA adjustable with the electrically adjustable KNEE BEND.
Actuator 4	LEGREST electrically adjustable.

- The armrests and the headrest of the MLW F1 with 4 actuators (S / M / L) are pneumatically adjustable.
- The **pneumatically** adjustable armrests can be lowered **and** swiveled.
- The hand control of the MLW F1 (S / M / L) is equipped with eight memory positions.

10.2.2 MLW F1 / with 6 actuators / Widths: Medium, Large

MLW F1 (M / L) // WITH 6 ACTUATORS	
Actuator 1	Electrical HEIGHT ADJUSTMENT.
Actuator 2	BACKREST electrically adjustable.
Actuator 3	INCLINATION OF THE SEAT AREA, adjustable with the electrically adjustable KNEE BEND.
Actuator 4	LEGREST electrically adjustable.
Actuator 5 / 6	ARMRESTS electrically adjustable (optional equipment)

- The electrically adjustable armrests **cannot** be swiveled.
- The headrest of the MLW F1 with 6 actuators (M / L) is **pneumatically** adjustable.
- The hand control of the MLW F1 (M / L) is equipped with eight memory positions.

i The MLW F1 with six actuators (electrically adjustable armrests) is **only** available in the MEDIUM and LARGE widths.

10.3 Before first use

- Before using the MLW for the first time, make sure that all parts are present (s. chapter 3. SCOPE OF DELIVERY) and that there is no visible damage.
 - Make sure that the safety socket for the MLW is properly grounded and has the correct power voltage (230 V AC).
- i** Before setting up, make sure that sufficient space is provided for the MLW.

10.4 View (Example: MLW F1 Wood)

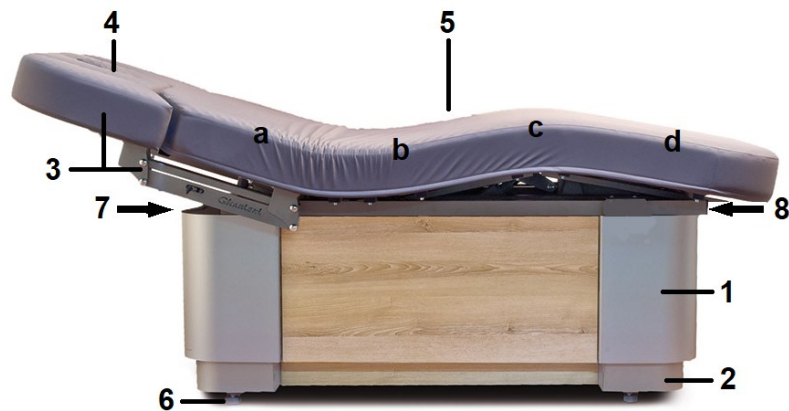

Fig. similar: colour, finish and equipment may vary depending on the model.

1	BASE (supporting structure) / UPPER HOUSING
2	BASE (supporting structure) / LOWER HOUSING: ➤ s. chapter 6.2.1 USE OF THE CARRYING AIDS.
3	ARMRESTS: ➤ pneumatically adjustable and swiveling; s. chapter 9.5 GAS SPRINGS and chapter 10.7.1 PNEUMATICALLY ADJUSTABLE ARMRESTS. ➤ Optionally , electrically adjustable armrests (non-swiveling) are also available; s. chapter 10.7.2 ELECTRICALLY ADJUSTABLE ARMRESTS (OPTIONAL EQUIPMENT).
4	HEADREST: ➤ pneumatically adjustable ➤ With nose slit ➤ s. chapter 10.5 GAS SPRINGS and chapter 10.6 HEADREST

5	<p><u>LYING SURFACE, DIVIDED INTO:</u></p> <p>a. BACKREST</p> <ul style="list-style-type: none"> ➤ electrically adjustable ➤ s. chapter 10.9 BACKREST and chapter 11.3 ADJUSTMENT OF THE BACKREST. <p>b. SEAT</p> <ul style="list-style-type: none"> ➤ Thigh area to knee area. <p>c. KNEE BEND (INCLINATION OF THE SEAT AREA)</p> <ul style="list-style-type: none"> ➤ The INCLINATION OF THE SEAT AREA can be adjusted by the electrically adjustable KNEE BEND. ➤ s. chapter 11.4 ADJUSTMENT OF THE INCLINATION OF THE SEAT AREA. <p>d. LEGREST</p> <ul style="list-style-type: none"> ➤ electrically adjustable ➤ s. chapter 10.8 LEGREST and chapter 11.5 ADJUSTMENT OF THE LEGREST.
6	<p><u>ADJUSTABLE FEET:</u></p> <ul style="list-style-type: none"> ➤ s. chapter 6.2.1 USE OF THE CARRYING AIDS.
7	<p><u>HEAD END OF THE SPA TABLE:</u></p> <ul style="list-style-type: none"> ➤ The rating plate is in the housing at the head end of the spa table, on the construction below the headrest and backrest. ➤ s. chapter 7. RATING PLATE.
8	<p><u>FOOT END OF THE SPA TABLE:</u></p> <ul style="list-style-type: none"> ➤ Inside the housing at the foot end of the spa table, below the legrest, is the lever for extending the castors. ➤ s. chapter 6.2.2 EXTENDABLE/RETRACTABLE CASTORS.

10.5 Gas springs

- ❖ The two armrests and the headrest on the MLW F1 with 4 actuators are adjusted using a gas spring (pneumatic); on the MLW F1 with 6 actuators, only the headrest is adjustable pneumatically.
- ❖ If you make an adjustment using the gas spring lever, you **only** need to operate the lever **when lowering**.
- ❖ To **raise** an armrest and / or the headrest again, perform a pulling movement **upwards** (**without operating the corresponding lever**).

10.6 Headrest

⚠ WARNING! Never exert physical force on the headrest, regardless of the setting of the lying surface. Non-compliance with this instruction may permanently damage the support structure of the MLW.
RISK OF TIPPING! RISK OF BREAKAGE! RISK OF INJURY!

- i** The headrest is manually continuously adjustable (see below, fig. 1,2 and 3).
 - i** By pressing the lever on the side of the gas spring (see below, fig. 1), the headrest can be tilted as required (positively and negatively by 30° each) and locked by releasing it.
- See also chapter 10.5 GAS SPRINGS.



FIG. 1



FIG. 2

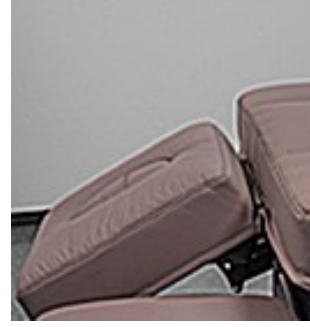

FIG. 3

*Fig. similar: fig. serve **exclusively** as an example.*

- ❖ The upholstery of the headrest is equipped with a nose slit for back massages. For this purpose, the headrest is equipped with a separate upholstered part which can be removed (see below, fig. 4).
- ❖ By placing an optionally available face gel cushion (see below, fig. 5) on the headrest, the face of the person to be treated can be additionally supported (s. also chapter 23.1 GEL CUSHION FOR NOSE SLOTS).



FIG. 4



FIG. 5

*Fig. similar: fig. serve **exclusively** as an example.*

- ❖ The „DENTALAX“ NECKREST is optionally available for the MLW. (s. chapter 23.3 NECKREST "DENTALAX"). The NECKREST "DENTALAX" provides anatomical support for the cervical vertebrae and increasing the lying sensation considerably.

NOTICE! Do not lean against the headrest! Never stand, rest, or sit on the headrest; otherwise you may permanently damage it!
RISK OF DAMAGE!

10.7 Armrests

⚠ WARNING! Never exert physical force on the armrests, regardless of the setting of the lying surface. Non-compliance with this instruction may permanently damage the support structure of the MLW. RISK OF TIPPING! RISK OF BREAKAGE! RISK OF INJURY!

NOTICE! Please note that the armrests must always be in the basic position (see below, fig. 6) before adjusting the position of the backrest. Otherwise, the armrests may collide with the floor, become trapped and/or seriously damaged (see fig. below, fig. 7 and 8).



FIG. 6



FIG. 7



FIG. 8

10.7.1 Pneumatically adjustable armrests

- ❖ The armrests of the MLW F1 can be lowered or raised manually using a gas spring in the same way as the headrest (s. also chapter 10.5 GAS SPRINGS).
 - ❖ The pneumatically adjustable armrests of the MLW F1 can also be swiveled.
 - ❖ By operating the lever on the respective side and exerting slight pressure, they can also be adjusted continuously.
 - ❖ This makes the spa table ideal for back massages (s. fig. below).
- i** By swinging down the armrests, you can also move closer to the head of the person being treated during cosmetic treatments or facial massages.

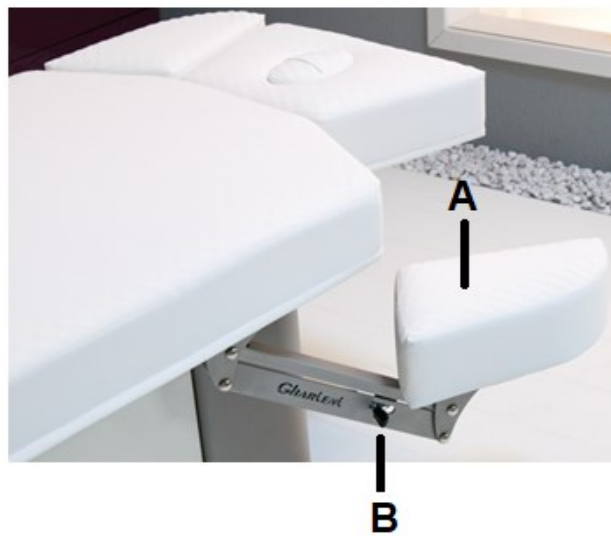

A	pneumatically LOWERABLE and SWIVELING ARMREST
B	GAS SPRING LEVER of the armrest

NOTICE! The armrests may only be swung down without load!
Do not lean against the armrests! Never stand, sit, or kneel on the armrests! RISK OF DAMAGE!

NOTICE! The **maximum** load of the armrests is 25 kg.
RISK OF DAMAGE!

10.7.2 Electrically adjustable armrests (optional equipment)

- ❖ Electrically adjustable armrests for the MLW F1 MEDIUM and LARGE are optionally available for an extra charge.
- ❖ For the MLW F1 SMALL electrically adjustable armrests are **not available**.

i **ELECTRICALLY ADJUSTABLE ARMRESTS CANNOT BE SWIVELED!**

1. On the side of the armrests is the control button (s. fig. below) for adjusting the armrests.
2. Press and hold the corresponding arrow on the control button (s. fig. below) to lower or raise the armrests.
3. When the button is released, the movement stops immediately.

i For the **direction of movement**, please observe the arrow symbols on the control button.

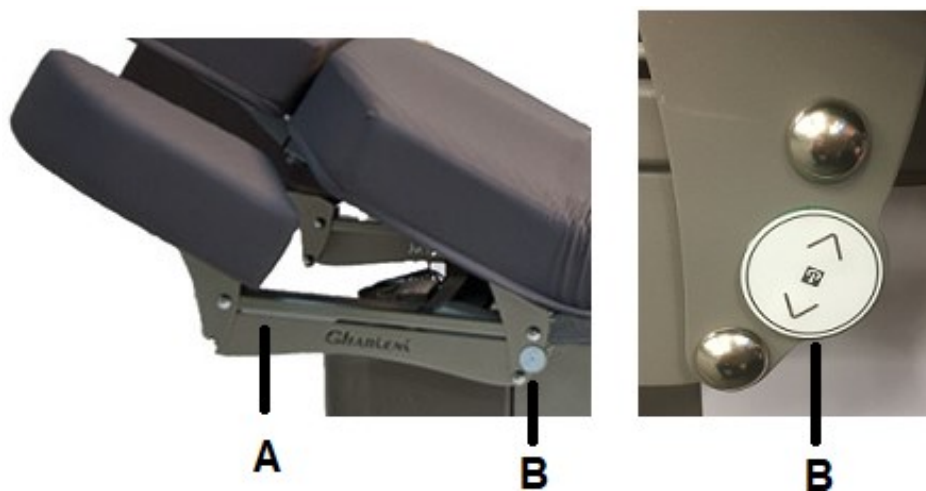

A	electrically adjustable ARMREST
B	CONTROL BUTTON for lowering or raising the armrests

NOTICE! Do not lean against the armrests! Never stand, sit, or kneel on the armrests; otherwise you may permanently damage them!
RISK OF DAMAGE!

NOTICE! The **maximum** load of the armrests is 25 kg.
RISK OF DAMAGE!

10.8 Legrest

- ❖ The legrest of the MLW can be electrically adjusted independently of the backrest using the hand control (s. chapter 11.5 ADJUSTMENT OF THE LEGREST).
 - The seat area must be raised for this (s. chapter 11.4 ADJUSTMENT OF THE INCLINATION OF THE SEAT AREA).

10.9 Backrest

- ❖ The backrest of the MLW can be adjusted electrically (s. chapter 11.3 ADJUSTMENT OF THE BACKREST).

11. Electrical adjustments

- ❖ The electrical adjustments of the MLW are made, among other things, with a hand control.
- ❖ **Optionally**, the adjustments can also be made with an infrared remote control or a foot control (s. chapter 12. FOOT CONTROL and chapter 13. INFRARED REMOTE CONTROL).
- i** If you have chosen the VIBRO WELLNESS 10 option, an additional hand control is supplied for this option; s. chapter 16. VIBRO WELLNESS 10 (OPTIONAL EQUIPMENT).



For safety reasons, the spa table only moves if you keep a button of the hand control pressed. When you release it, the movement stops immediately.

11.1 Hand Control

The hand control is a cable-connected control. It enables the operation of the electrically controllable functions.

- i** Saving certain spa table positions is described in MEMORY FUNCTIONS OF THE HAND CONTROL (s. chapter 11.1.2).
- ❖ You can control each of the 4 actuators by pressing the corresponding push-button pairs (level 1, standard mode, black labelling).
- ❖ Furthermore, you can adjust and save up to eight memory positions (level 2, shift mode, grey labelling).

- ❖ The hand control has 12 buttons; the upper 8 buttons are assigned to **both** levels.

LEVEL 1 / STANDARD MODE / BLACK LABELLING

- ACTUATOR CONTROL (working height / backrest / inclination of the seat area / legrest)
- LOCK BUTTON (lock and unlock the hand control)

LEVEL 2 / SHIFT MODE / GREY LABELLING

- Allocation and recall of the MEMORY POSITIONS (M 1 - M 8)
- SHIFT BUTTON (changes between level 1 and level 2)
- START BUTTON (returns the MLW to the start position / **only** in level 2)
- MEMORY BUTTON (store any treatment position on the target buttons / memory positions M 1 - M 8)

- ★ If the hand control is in level 2, the LED above the SHIFT BUTTON lights up. In Level 1, the LED is off.

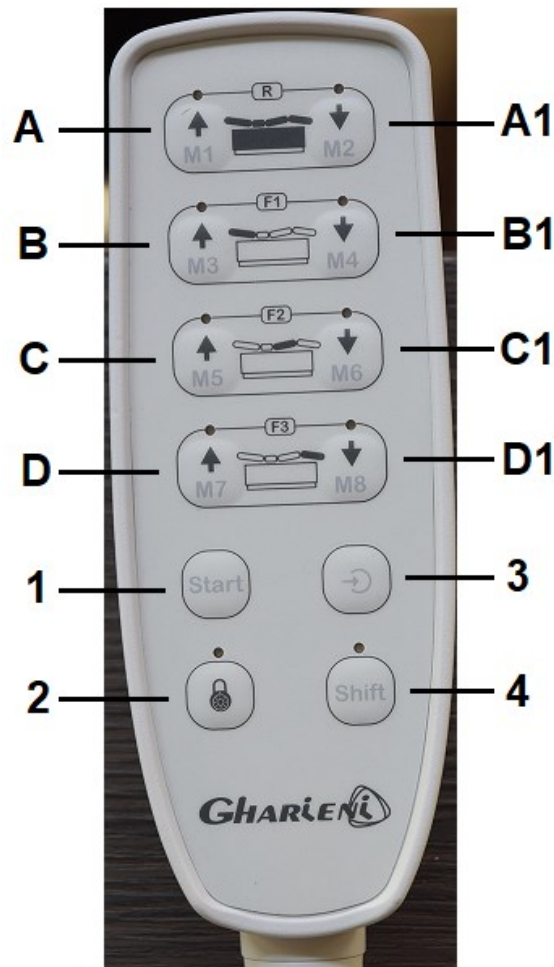

A / A1	<ul style="list-style-type: none"> ➤ Buttons for adjustment of the WORKING HEIGHT (black labelling / arrows). ➤ Buttons for adjusting and recalling the MEMORY POSITIONS M 1 and M 2 (grey labelling).
B / B1	<ul style="list-style-type: none"> ➤ Buttons for adjustment of the BACKREST (black labelling / arrows). ➤ Buttons for adjusting and recalling the MEMORY POSITIONS M 3 and M 4 (grey labelling).
C / C1	<ul style="list-style-type: none"> ➤ Buttons for adjustment of the INCLINATION OF THE SEAT AREA / KNEE BEND (black labelling / arrows). ➤ Buttons for adjusting and recalling the MEMORY POSITIONS M 5 and M 6 (grey labelling).
D / D1	<ul style="list-style-type: none"> ➤ Buttons for adjustment of the LEGREST (black labelling / arrows). ➤ Buttons for adjusting and recalling the MEMORY POSITIONS M 7 and M 8 (grey labelling).
1	<p><u>START BUTTON (level 2 button / grey labelling):</u></p> <ul style="list-style-type: none"> ➤ The START BUTTON returns the MLW to the start position or is without function². ➤ The start position cannot be changed. ➤ Only available in Level 2.
2	<p><u>LOCK BUTTON (level 1 button / black labelling):</u></p> <ul style="list-style-type: none"> ➤ The LOCK BUTTON locks or releases the hand control. ➤ Only available in Level 1.
3	<p><u>MEMORY BUTTON (level 2 button / grey labelling):</u></p> <ul style="list-style-type: none"> ➤ With the MEMORY BUTTON you can allocate any positions on the target buttons (memory positions) M 1 - M 8. ➤ Only available in Level 2.
4	<p><u>SHIFT BUTTON:</u></p> <ul style="list-style-type: none"> ➤ With the SHIFT BUTTON you can change between level 1 and level 2. ➤ If the hand control is in level 2 mode, the LED above the SHIFT BUTTON lights up.

² Depending on model

⚠ WARNING! When adjusting the treatment position, make sure that there are no body parts or objects between the spa table's parts.
RISK OF CRUSHING!

NOTICE! For safety reasons, the spa table only moves if you press a button on the hand control. When you stop pressing, the movement stops immediately.

11.1.1 Lock function / lock button of the hand control

❖ The MLW F1 is equipped with a hand control LOCK FUNCTION to protect it from unauthorized use.

ACTIVATING THE LOCK FUNCTION

1. To activate the lock function of the hand control, press the LOCK BUTTON (2 / **hold it down**) and then **immediately** (within one second) press the SHIFT BUTTON (4).
2. Keep both buttons pressed until an acoustic signal sounds.
3. The LED indicator of the LOCK BUTTON **lights up**.
4. The operation of the spa table is now blocked.



DE-ACTIVATING THE LOCK FUNCTION

To release the hand control, press the LOCK BUTTON (2 / **hold it down**) and then **immediately** (within one second) press the SHIFT BUTTON (4).

5. Keep both buttons pressed for approx. 3 seconds until an acoustic signal sounds.
6. The LED indicator of the LOCK BUTTON **goes out**.
1. The operation of the spa table is now enabled.



NOTICE! To prevent unauthorized use of the MLW F1, always activate the lock function of the hand control when leaving the treatment room.

11.1.2 Memory functions of the hand control

- ❖ The hand control of the MLW F1 has eight memory positions (memory positions on level 2: M1 / M2 / M3 / M4 / M5 / M6 / M7 / M8).
- ❖ The memory function saves the treatment positions you want and thus makes your work easier. Use the buttons M1 - M8 (s. fig in chapter 11.1 HAND CONTROL).

STORING THE MEMORY POSITIONS:

1. Adjust the desired position as usual.
2. Press the SHIFT BUTTON (4). The LED indicator **lights up**. (LEVEL 2 OPERATION).
3. Press the MEMORY BUTTON (3).
4. Then press the desired MEMORY BUTTON M 1 - M 8.
5. When the position has been successfully stored, an acoustic signal will sound.



M 1 - M 8

RECALLING THE MEMORY POSITIONS:

1. Press the SHIFT BUTTON (4). The LED indicator **lights up**. (LEVEL 2 OPERATION).
2. Press and **hold** the corresponding MEMORY BUTTON M 1 - M 8 **until** the stored memory position is reached.



M 1 - M 8

ONLY FOR MODELS WITH ELECTRICALLY ADJUSTABLE ARMRESTS:

- i** If your MLW is equipped with electrically adjustable armrests, the positions of the armrests adjusted during storing of a treatment position are also stored; i.e. when a memory position is recalled, the armrests are also moved to the position they were in during storing.

11.2 Adjustment of the working height

- ❖ For adjustment of the WORKING HEIGHT, press the corresponding push-button pair (**A / A1**); s. fig. in chapter 11.1 HAND CONTROL.
 - ❖ For the direction of movement, please observe the arrow symbols on the hand control.
 - ❖ The horizontal WORKING HEIGHT of the **MLW F1 WOOD** is adjustable from approx. 58 cm to approx. 91 cm (with the feet turned in).
 - ❖ The horizontal WORKING HEIGHT of the **MLW F1 SOFT** is, adjustable from approx. 63 cm to approx. 96 cm (with the feet turned in) due to the slightly thicker upholstery.
 - ❖ By unscrewing the feet (up to approx. 3 cm), you can increase the working height slightly.
- i** The ENTRY HEIGHT is the lowest adjustment of the seat.
This is indicated in the horizontal position of the seat.
- **MLW F1 Wood** = approx. 58 cm / seat in horizontal position
 - **MLW F1 Soft** = approx. 63 cm / seat in horizontal position

11.3 Adjustment of the backrest

- ❖ The inclination of the backrest can also be adjusted using the hand control.
- ❖ For adjustment of the BACKREST press the corresponding push-button pair (**B / B1**); s. fig. in chapter 11.1 HAND CONTROL.
- ❖ For the direction of movement, please observe the arrow symbols on the hand control.

⚠ WARNING! When adjusting the treatment position, make sure that there are no body parts or objects between the spa table's parts.
RISK OF CRUSHING!

NOTICE! Please note that the position of the backrest may only be adjusted when the armrests are in their basic position. Otherwise the armrests may collide with the floor, become trapped and/or seriously damaged; see also fig. 6,7 and 8 in chapter 10.7 ARMRESTS.

11.4 Adjustment of the inclination of the seat area

- ❖ The inclination of the seat area can also be adjusted using the hand control using the electrically adjustable knee bend; s. fig. in chapter 10.4 VIEW (EXAMPLE: MLW F1 WOOD).
- ❖ It covers the complete thigh area up to the knee bend.
- ❖ For adjustment of the INCLINATION OF THE SEAT AREA, press the corresponding push-button pair (**C / C1**); s. fig. in chapter 11.1 HAND CONTROL.
- ❖ For the direction of movement, please observe the arrow symbols on the hand control.

11.5 Adjustment of the legrest

- ❖ The inclination of the legrest can also be adjusted using the hand control. The seat area must be raised for this (s. chapter 11.4 ADJUSTMENT OF THE INCLINATION OF THE SEAT AREA).
- ❖ For adjustment of the INCLINATION OF THE SEAT AREA, press the corresponding push-button pair (**D / D1**); s. fig. in chapter 11.1 HAND CONTROL.
- ❖ For the direction of movement, please observe the arrow symbols on the hand control.

12. Foot Control

- ❖ The foot control (see below, fig. 9) can be connected as an option to the hand control or the infrared remote control.
 - ❖ The foot control consists of a right and a left part connected to an electronic part (see below, fig. 10) on which the light diodes are located.
 - ❖ The foot control allows control of the basic functions as well as recall of previously stored memory positions.
- i** When purchasing an MLW F1, one control can be selected: hand control, infrared remote control, or foot control. Only one of these is included in delivery; the other two can be purchased at extra cost.

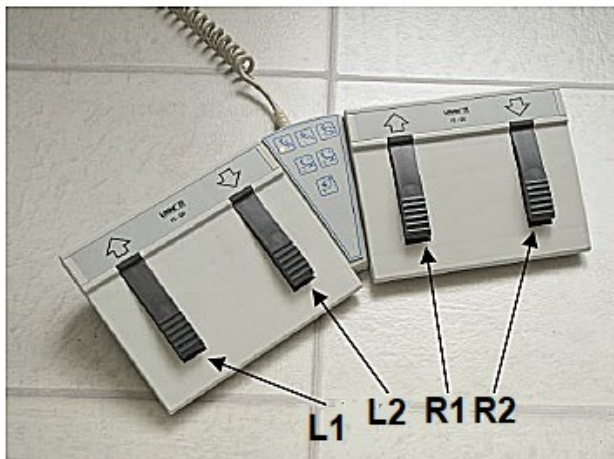

FIG. 9



FIG. 10

SELECT FUNCTIONS:

R 1	<p><u>R 1 / Right part of the foot control:</u></p> <ul style="list-style-type: none"> ➤ Serves as STORAGE BUTTON when the memory function is selected.
R 2	<p><u>R 2 / Right part of the foot control:</u></p> <ul style="list-style-type: none"> ➤ Selects the ACTUATORS (height, backrest, inclination of the seat area, legrest) OR the MEMORY - FUNCTION (LOWER DIODE) <u>step by step</u>. The corresponding diodes on the central electronic part (see above, fig. 10) light up.

ADJUSTING THE ACTUATORS:

1. Select the actuators you want to adjust (height, backrest, inclination of the seat area, legrest) with the **R 2** pedal on the **right** part of the foot control. To do this, press the **R 2** pedal repeatedly until the LED of the desired actuator lights up on the central electronic part (s. fig. 10).
2. Press pedals **L 1** or **L 2** on the **left** part of the foot control to extend or retract the selected actuator (s. fig. 9). For the direction of movement, please see the arrow symbols on the stickers of the foot control.

STORING A MEMORY POSITION:

1. Adjust the desired treatment position as usual.
2. Press the **R 2** pedal of the **right** part of the foot control repeatedly until the **lower diode** of the central electronic part lights up (s. fig. 10).
3. Press the **R 1** pedal to save the treatment position.
4. Now select the corresponding memory buttons **L 1** (Memory 1) or **L 2** (Memory 2) on the **left** part of the foot control. Press and hold the **L 1** or **L 2** pedals until an acoustic signal sounds.
5. The adjusted treatment position is stored.

RECALLING A STORED MEMORY POSITION:

- i** Two memory positions can be recalled using the left part of the foot control.
1. Press the **R 2** pedal of the **right** part of the foot control repeatedly until the **lower diode** of the central electronic part (s. fig. 10) lights up.
 2. Then press and hold the pedals **L 1** or **L 2** of the **left** part of the foot control until the stored treatment position is reached.

ONLY FOR MODELS WITH ELECTRICALLY ADJUSTABLE ARMRESTS:

- i** If your MLW is equipped with electrically adjustable armrests, the position of the armrests adjusted during storage of a treatment position is also stored; i.e. when a memory position is recalled, the armrests are also moved to the position they were in during storage.

13. Infrared remote control

- ❖ The infrared remote control enables wireless operation of the electrically controlled functions. The four actuators can be adjusted individually at the touch of a button. In addition, you can store and recall up to eight memory positions.
- i** To ensure the function of the remote control, the remote control must have a free connection to the infrared receiver. Please point the remote control at the center of the bed.



For safety reasons, the spa table only moves if you keep one button of the hand control pressed. When you release the button, the movement stops immediately.

- i** When purchasing an MLW F1, one control can be selected: hand control, infrared remote control, or foot control. Only one of these is included in delivery; the other two can be purchased at extra cost.

13.1 Operation

The individual functions (height, backrest, inclination of the seat area and legrest) are operated electrically. To control the corresponding functions, press the respective button on the remote control.

MEMORY FUNCTION

- ❖ The memory function allows you to store up to 8 frequently used positions using the buttons M 1 to M 8 on the remote control (**LEVEL 2 MODE**).

STORING A MEMORY POSITION:

1. Adjust the desired area as usual.
2. Press the SHIFT BUTTON, to switch to LEVEL 2 MODE.
3. Press the MEMORY BUTTON.
4. Then press the desired MEMORY BUTTON M 1 - M 8.
5. After successful storage, an acoustic signal will sound.



M 1 - M 8

RECALLING A STORED MEMORY POSITION:

1. Press the SHIFT BUTTON, to switch to LEVEL 2 MODE.
2. Press and **hold** the respective MEMORY BUTTON M 1 - M 8 **until** the stored treatment position is reached.



M 1 - M 8

ONLY FOR MODELS WITH ELECTRICALLY ADJUSTABLE ARMRESTS:

- i** If your MLW is equipped with electrically adjustable armrests, the position of the armrests adjusted during storage of a treatment position is also stored; i.e. when a memory position is recalled, the armrests are also moved to the position they were in during storage.

LOCK BUTTON:

- ❖ The remote control is equipped with a lock button to protect it from unauthorized use.

LOCKING THE REMOTE CONTROL:

1. To lock the remote control, press and **hold** the LOCK BUTTON for **three seconds** until an acoustic signal sounds.
2. Operation of the remote control is now blocked.



UNLOCKING THE REMOTE CONTROL:

1. To unlock the remote control, press and hold the SHIFT BUTTON and then immediately press and hold the lock button for two seconds until an acoustic signal sounds.
2. You can now access the remote control functions.



NOTICE! To prevent unauthorized use of the MLW F1, always activate the lock function of the remote control when leaving the treatment room.

14. Smart Thermo heating system (optional equipment)

- ❖ The lying surface of MLW can be heated to maximize the treatment comfort. The Smart Thermo is a pre-programmed and fully automatic heating system which allows a comfortable operation. The intelligent Smart Thermo heating system is integrated into the upholstery of the MLW and works with modern microprocessor technology. The Smart Thermo heating system for the MLW is optionally available for an additional charge.
- ❖ Due to the pre-programmed microchip, you **only** must switch on the Smart Thermo with the “On” - button to start the automatic heating program. For quick heating of a cold lying surface, after starting the Smart Thermo will operate with max. power during the pre-heating period. The heating program of the Smart Thermo is fully automated and switches off automatically after a total running time of 100 minutes.
- s. chapter 14.1 OPERATION / BUTTON -ON-
- ❖ The heating parameters of the Smart Thermo can be programmed and saved if desired (s. chapter 14.1 OPERATION). If desired, you can set 5 heating levels using the control panel of the Smart Thermo heating system (s. fig. in chapter 14.1).
- ❖ Check the current temperature before using the MLW. Disconnect the MLW from the mains when it is not used for a longer period, e.g. during the night.

 **WARNING!**





1. **Do not use** the Smart Thermo when your customer
 - has got a pacemaker.
 - is pregnant.
 - is affected by thrombosis.
 - suffers from pain due to unknown reasons.
2. Apply to healthy people **only**.
3. When the treatment is stopped prematurely, cancel the Smart Thermo by pressing the OFF-button on the control panel to avoid heat accumulation.
4. Disconnect the MLW from the mains when it is not used for a longer period, e.g. during the night.

 **WARNING!** People with acute pain, venous disorders, low blood pressure, inflammatory processes and other medical conditions that make heat applications or this form of client positioning questionable must always consult a doctor before use.

 **WARNING!** Never use the MLW on people who are under the influence of alcohol or drugs.

 **WARNING!** The cables of the models with the heating system are located between the upholstery and metal rack (depending on model). **The upholstery may only be removed by persons authorised by us!**

14.1 Operation

- ❖ You can operate the heating system using the 4 buttons ,  and ,  (s. fig. below: CONTROL PANEL OF THE SMART THERMO HEATING SYSTEM).
- ❖ The setting of the heating power and the time selection is indicated by a 10-level LED bar-diagram.

CONTROL PANEL OF THE SMART THERMO HEATING SYSTEM:



BUTTON: -ON-



BUTTON: -OFF-



TEMPERATURE SELECTION BUTTON



TIME SELECTION BUTTON

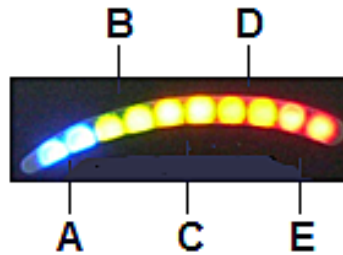

LEDs:



A	2 blue LEDs
B	2 green LEDs
C	2 yellow LEDs
D	2 orange LEDs
E	2 red LEDs



BUTTON -ON-:

- ❖ Press this button to switch **on** the Smart Thermo.
- 1. When the Smart Thermo is switched on, it starts heating at the maximum heating / power level for **5 minutes** (**level 5**: the 2 **red** LEDs (**E**) are illuminated).
- 2. After the 5 minutes have elapsed, the Smart Thermo will keep heating at the minimum heating / power level automatically for additional **95 minutes** (**level 1**: the 2 **blue** LEDs (**A**) are illuminated).
- 3. After a total time of **100 minutes**, the Smart Thermo will be switched off automatically.
- ❖ This sequence is pre-programmed.
- The **heating / power level** and the **heating time** of the Smart Thermo can be changed at any time by using the corresponding buttons (s. description below:
 -  TEMPERATURE SELECTION BUTTON /  TIME SELECTION BUTTON).



BUTTON -OFF-:

- ❖ Press this button to switch **off** the Smart Thermo.



TEMPERATURE SELECTION BUTTON:





- ❖ Press this button to adjust the **temperature** of the Smart Thermo for the setting of the required heat.

FIVE HEATING / POWER LEVELS ARE AVAILABLE:

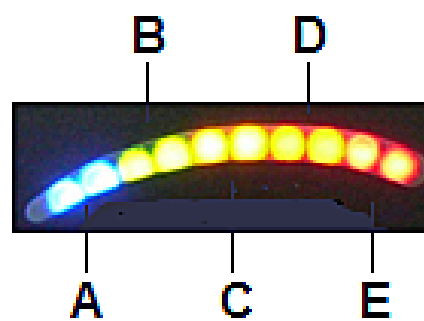
Level 1	Minimum power = low temperature
Level 2	Heating / power level between minimum and medium power
Level 3	Medium power = medium temperature
Level 4	Heating / power level between medium and maximum power
Level 5	Maximum power = high temperature

The selected heating / power level will be displayed on the LEDs above the operating buttons:



Press button  one time	Level 1	blue LEDs (A)
Press button  two times	Level 2	green LEDs (B)
Press button  three times	Level 3	yellow LEDs (C)
Press button  four times	Level 4	orange LEDs (D)
Press button  five times	Level 5	red LEDs (E)

- By pressing the button  once more (**six times**) the selection cycle will begin at **level 1** again





TIME SELECTION BUTTON:

- ❖ Press this button to set the required **heating time** of the Smart Thermo.
- **Ten time settings** (in 10-minutes intervals) are available which are displayed on the LEDs (10 LEDs).
- You can select a heating time from **10 minutes up to 100 minutes** by pressing the TIME SELECTION BUTTON one or several times.
- Thereby one illuminated LED corresponds to 10 minutes.
- When the desired time selection has elapsed, the Smart Thermo switches off **automatically**.

EXAMPLE:

You wish to set a medium heating / power level (level 3) of 30 minutes. Please proceed as follows:

1. Switch on the Smart Thermo by pressing the button -ON- .
2. Then select the TEMPERATURE SELECTION BUTTON . Press this button repeatedly until the **two yellow LEDs (C)** are illuminated (s. fig. below).



3. The appliance is now set to medium heating / power level (**level 3**).
4. Then select the TIME SELECTION BUTTON .
5. Press this button repeatedly until **three** of the ten LEDs are illuminated (**two blue LEDs and one green LED** / s. fig. below).



6. **One** illuminated LED corresponds to a heating time of **10 minutes**.
 7. Now the appliance heats for 30 minutes at the selected heating / power level.
 8. After the set time has elapsed the Smart Thermo switches off **automatically**.
- If you wish to quit the heating time **earlier**, press the button  to switch off the Smart Thermo.
- ❖ When programming the Smart Thermo it does not matter whether you wish to set the time **at first** and the temperature **secondly or** vice versa.
 - ❖ It is not possible to switch on the heating function **without** the time selection. The minimum heating time is 10 minutes (**one** illuminated LED). The maximum heating time is 100 minutes (**ten** illuminated LEDs).
 - ❖ The selected settings can be checked at any time by pressing the relevant button.
 - ❖ The Smart Thermo is equipped with a memory function, which enables the previous settings automatically after power up.

15. Audio Relax Headrest (optional equipment)

The AUDIO RELAX HEADREST is optionally available for the MLW, for an additional charge. The AUDIO RELAX HEADREST is equipped with integrated speakers and guarantees a pleasantly relaxing sound experience with the greatest comfort.

This option supports optimal relaxing of your customers and adds an individual touch to your massages. Two speakers built into the side of the headrest support the massage by providing a unique sound experience for your clients.

The volume is **not** intended to provide sound in rooms.

16. Vibro Wellness 10 (optional equipment)

- ❖ The VIBRO WELLNESS 10 FUNCTION for the MLW is optionally available for an additional charge. VIBRO WELLNESS 10 is a pleasantly massaging vibration system and includes many various adjustment options.

WARNING!

1. **Do not use** the option Vibro Wellness 10 if your customer
 - has got a pacemaker.
 - is pregnant.
 - is affected by thrombosis.
 - suffers from pain due to unknown reasons.
2. Apply to healthy people **only**.

 **WARNING!** Do not open the housing of the hand control!
Non-compliance **will expire the guarantee**.

 **WARNING!** Liquids **must not** get into the hand control.
RISK OF ELECTRIC SHOCK!

 **WARNING!** **Persons with a pacemaker must not operate or use the massage unit as the pacemaker can be negatively influenced!**

 **WARNING!** The cables of the models incl. the Vibro Wellness 10 function are between the upholstery and metal rack (depending on model). **Removing of the upholstery must be carried out by authorized professionals only!**

16.1 Hand Control

- ❖ The 10 motors of the VIBRO WELLNESS 10 function are installed in different sections of the lying surface (s. fig. 11 / below).
- ❖ Use the associated control panel (s. fig. 12 / below) to activate the individual sections in pairs.

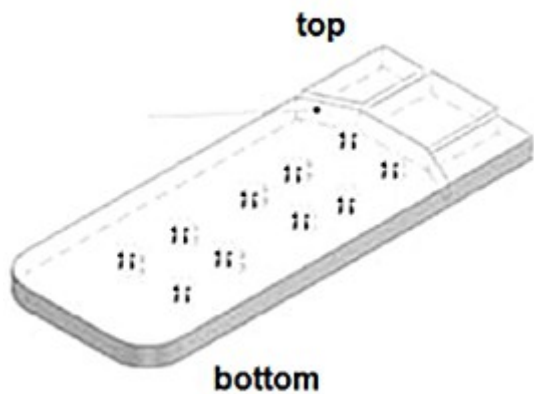

(fig. similar / fig. serves as an example only)

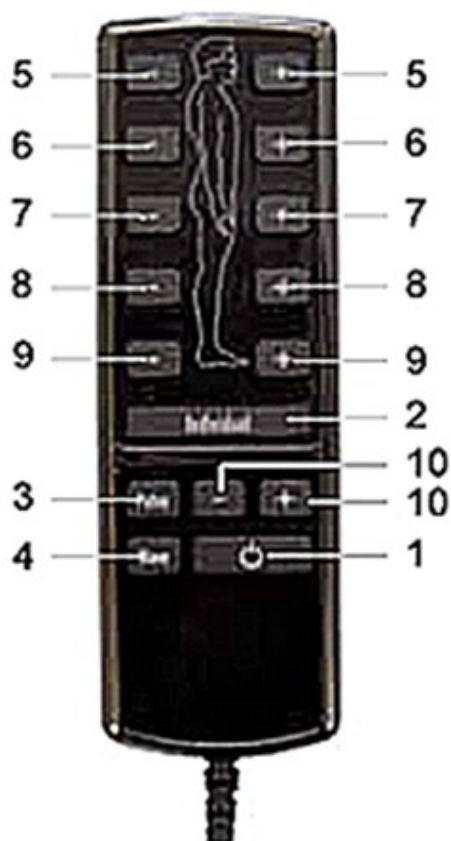

FIG. 11

FIG. 12

1	ON / OFF BUTTON
2	INDIVIDUAL BUTTON
3	PULSE-MASSAGE BUTTON (PULSE BUTTON)
4	WELLNESS-MASSAGE BUTTON (WAVE BUTTON)
5	INTENSITY BUTTONS: SHOULDER AREA / BACK AREA
6	INTENSITY BUTTONS: FUSELAGE AREA / BACK AREA
7	INTENSITY BUTTONS: PELVIC AREA / BACK AREA
8	INTENSITY BUTTONS: LEG AREA
9	INTENSITY BUTTONS: CALF AREA / FOOT AREA
10	Button to change the SPEED of the PULSE-MASSAGE PROGRAM and WELLNESS-MASSAGE PROGRAM (three levels).

16.2 Operation

HOW TO START A MESSAGE:

- You can start a message by pressing the FOLLOWING BUTTONS:

ON / OFF BUTTON (1)

- ❖ When the massage unit is operated for the first time, the setting INDIVIDUAL is activated.
- ❖ All massage motors operate in the manufacturer's setting (intensity level 2 / medium intensity).
- ❖ When the massage unit has been operated before, the previously-set program is started again (INDIVIDUAL, PULSE OR WELLNESS MESSAGE).

INDIVIDUAL BUTTON (2)

- ❖ When the massage unit is operated for the first time, the manufacturer's setting is activated (intensity level 2 / medium intensity).
- ❖ When an individual setting has been set before (s. below: INDIVIDUAL SETTING), the previously-set setting is started again.

PULSE-MESSAGE BUTTON (3)

- ❖ Start this message with the **first** of the three pulse-massage program.

WELLNESS-MESSAGE BUTTON (4)

- ❖ Start this message with the **first** of the three wellness-massage program.

INTENSITY BUTTONS (5-9)

- ❖ Pressing one of these buttons sets the relevant massage motor to intensity level 1.
- i** **Please note:** Doing so will overwrite a previously-set individual setting (s. below: INDIVIDUAL SETTING)!

INDIVIDUAL SETTING (2):

- Start the massage by pressing the INDIVIDUAL BUTTON (2).
- When the massage unit is operated for the first time, the manufacturer's setting is activated (intensity level 2 / medium intensity).
- Now you can set each motor to **three levels** of intensity using the INTENSITY BUTTONS (5) - (9).
- The levels are indicated on the LED-display as follows.

<div style="display: flex; justify-content: space-around;"> □ □ □ </div> <div style="display: flex; justify-content: space-around;"> ■ □ □ </div> <div style="display: flex; justify-content: space-around;"> ■ ■ □ </div> <div style="display: flex; justify-content: space-around;"> ■ ■ ■ </div>	Level 0 (OFF) Level 1 Level 2 Level 3		
<input type="checkbox"/>	LED OFF	<input checked="" type="checkbox"/>	LED ON

- When the lowest intensity (level 1) has been reached, press one of the INTENSITY BUTTONS (5) - (9) again to switch off the relevant motor.
 - When you switch off all massage motors, the massage is stopped.
 - You can change from the manufacturer's setting (intensity level 2 / medium intensity) to your individual setting by pressing the INDIVIDUAL BUTTON (2).
- i** The individual settings are saved after the massage.

PULSE-MASSAGE (3):

- Press the PULSE-MASSAGE BUTTON (3) to start the massage with the **first** of the three programs.
 - Press the PULSE-MASSAGE BUTTON (3) a second time to start the **second** program.
 - Press the PULSE-MASSAGE BUTTON (3) a third time to start the **third** program.
 - When you press the PULSE-MASSAGE BUTTON (3) a fourth time, the **first** program will be started again.
 - You can select **three levels** of speed with the + and - BUTTONS (10).
 - You can select **three levels** of intensity with the INTENSITY BUTTONS (5) -(9).
- i Please note:** The PULSE-MASSAGE will be restarted in the manufacturer's setting.

WELLNESS-MASSAGE (4):

- Press the WELLNESS-MASSAGE / WAVE BUTTON (4) to start the massage with the **first** of the three programs.
 - Press the WAVE BUTTON (4) a second time to start the **second** program.
 - Press the WAVE BUTTON (4) a third time to start the **third** program.
 - When you press the WAVE BUTTON (4) a fourth time, the **first** program will be started again.
 - You can select **three levels** of speed with the + and - BUTTONS (10).
 - You can select **three levels** of intensity with the INTENSITY BUTTONS (5) - (9).
- i Please note:** The WELLNESS-MASSAGE will be restarted in the manufacturer's setting.

HOW TO FINISH A MESSAGE:

- ❖ A timer finishes a massage after 15 minutes automatically.
- ❖ If you want to stop the massage before, press the ON / OFF BUTTON (1).



The motors of the VIBRO WELLNESS 10 FUNCTION become louder when operating at the highest setting. This is not a cause for concern or complaint.

17. Triple Airback (optional equipment)

- ❖ The Triple-Airback technology is an electro-pneumatically 3-zone-lumbar-support-system of the upholstery and optional available for the MLW F1; for an additional charge.

⚠ WARNING! Read the following instructions carefully before you operate the Triple Airback for the first time.

⚠ WARNING! Do not operate the Triple Airback system, when it does not work properly or is visibly damaged. Ensure that it cannot be operated by third parties accidentally.

⚠ WARNING! Only operate the control unit if it is firmly mounted in a closed housing.

17.1 Scope of delivery

- Control unit incl. 3 rocker switches for the adjustment of the air cushions (s. chapter 17.3 CONTROL PANEL).

17.2 Characteristics

- ❖ The electrically-powered pneumatic Triple Airback System enables individual and ergonomic adjustments of the upholstery.
- ❖ There are three air cushions under the mattress underlay:
 - Air cushion 1 and air cushion 2 at the lumbar area.
 - Air cushion 3 at the thigh area.
 - s. fig. below



(Fig. similar; fig serves as an example only)

1	AIR CUSHION: UPPER PART OF THE LUMBAR AREA
2	AIR CUSHION: LOWER PART OF THE LUMBAR AREA
3	AIR CUSHION: THIGH AREA

- i** The Triple Airback system requires no installation from your side.
- i** The Triple Airback system does not require its own power supply. Power is supplied via the MLW.

17.3 Control panel

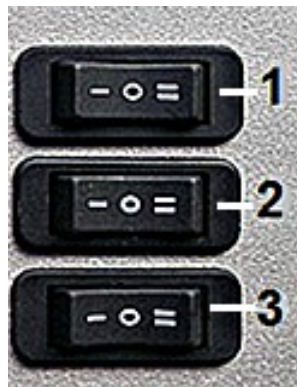

FIG. 10

(Fig. similar; modifications of the control panel are possible)

1	AIR CUSHION 1 (upper part of the lumbar area)
2	AIR CUSHION 2 (lower part of the lumbar area)
3	AIR CUSHION 3 (thigh area)
I	For deflating the air; air chambers are opened. ➤ Nevertheless, you must apply direct manual pressure.
II	For pumping the cushion.

17.4 Operation

❖ The air cushions can be inflated individually with an electrically operated pump:

1. **Rocker switch 1** on the control panel (s. above, chapter 17.3 CONTROL PANEL; fig. 10) operates air cushion **1** situated at the back section (upper part of the lumbar area).
 2. Press the same button in opposite direction to let the air out.
- **Rocker switch 2** (air cushion / lower lumbar area) and **rocker switch 3** (air cushion / thigh area) work in the same way.

NOTICE! Do not pump the air cushions too much; otherwise the air cushions can be damaged.

18. Multimedia Sound System (optional equipment)

- ❖ The integrated MULTIMEDIA-UNIT (MMU) offers a modern interface between various playback devices and your Spa Table.
- ❖ The speaker, which is integrated in the Spa Table, enables you to relax to your own favourite music.

- ❖ **The various players are not included in the scope of delivery.**

18.1 Abbreviation

MMU

➤ MULTIMEDIA UNIT

18.2 Safety information

 **WARNING!** Read the following instructions carefully before using the MMU for the first time.

SAFETY PRECAUTIONS:









To reduce the risk of electric shock, fire, or personal injury:

1. Use the MMU indoors **only**.
2. Keep the MMU away from water, liquids, or wet, damp areas.
RISK OF ELECTRIC SHOCK!
3. **Never** clean the MMU with a damp or wet cloth. Only use a dry cloth to clean the MMU. RISK OF ELECTRIC SHOCK!
4. **Never** repair the MMU yourself. RISK OF ELECTRIC SHOCK!
5. **Never** modify the MMU. RISK OF ELECTRIC SHOCK!
6. **Never** remove the cover of the docking station or other components of the MMU. RISK OF ELECTRIC SHOCK! RISK OF INJURY!
7. **Never** insert foreign objects into the MMU.
8. Keep the MMU away from open flames, e.g. candles etc.
RISK OF FIRE!
9. **Never** expose the MMU to direct sunlight.
10. **Never** expose the MMU to temperatures above 35 °C.
11. Excessive sound pressure from earphones and headphones can cause **damage to your hearing**. Make sure that the sound pressure is within the proper range.
12. Children under the age of 13 should **only** operate the MMU under supervision.

18.3 Control panel



(fig. similar: modifications are possible)

No.	ICON	FUNCTIONS
1		<u>ON / OFF:</u> ➤ Switch on / switch off the MMU.
2		➤ Press to switch from iPhone mode to BT mode, USB mode or AUX mode.
3		➤ Decrease volume.
4		➤ Increase volume.
5		<u>PLAY / PAUSE:</u> ➤ Play or Pause music tracks.
6		➤ Change between targeted sound for the head section and sound for the entire room.
7		➤ Press to play the next music track.
8		➤ Press to play the previous track. ➤ Press and hold = rewind in the current track.
9	DISPLAY	➤ Displays the different play modes.
10	DOCK	<u>CONNECTIONS:</u> USB / iPhone etc. / AUX



The bed has an integrated subwoofer that can be switched on by pressing the BASS button (6) on the MMU. By switching on the subwoofer, music is no longer audible specifically through the head section, but throughout the entire room. The music thus offers a deeper bass experience and thus an additional sound experience for your customers.

18.4 Compatibility

COMPATIBILITY IOS SYSTEM:	COMPATIBILITY ANDROID SYSTEM:
iPod touch 5	Version 4.2 or above i If your device does not connect, please try to update your device.
iPod Nano 7	
iPhone 4s	
iPhone 5 / 5s	
iPhone 6	
iPhone 6 Plus	
iPad 2 / 3 / 4	
iPad Air	

18.5 Playback of music / iPhone, Bluetooth, USB, AUX

NOTICE! When music is playing on the MMU using your **mobile phone**, incoming calls will immediately interrupt the music playback so that you answer the call.

PLAYING MUSIC USING THE IPOD / IPHONE / IPAD:

1. To play music using iPod / iPhone or iPad, press the **-FUNC-** button **(2)** repeatedly until the iPhone-MODE indicator **(9)** lights up on the MMU.
2. Then select the source option: play music on your iPod / iPhone or iPad.
3. The LED light of your iPod / iPhone or iPad also lights up, indicating that this device has been selected.



While your iPod / iPhone or iPad is **docked** to the MMU in this mode, it will automatically charge if needed.

- i** **INCOMING CALLS:** Incoming calls immediately interrupt your music playback, so you answer the call.

PLAYING MUSIC USING A BLUETOOTH (BT) CONNECTION:

1. To play music using a Bluetooth connection, press the **-FUNC-** button **(2)** repeatedly until the BLUETOOTH-MODE indicator **(9)** lights up on the MMU.
2. Then select and pair the desired source option (BLUETOOTH enabled device) with the MMU.

- i** The ID-Code of the MMU is **39X**.

- i** Press the **-PLAY / PAUSE-** **(5)** button to pause a call or the Bluetooth connection.

NOTICE! After you have selected BT, you can only use one device. There is no pairing password. Therefore, please switch off all other Bluetooth devices.



You could use the quick pairing function if your BLUETOOTH enabled device has a Near Field Communication (NFC). Turn on the NFC function on your device and then close the lid of the docking area (**A** / s. illustration below). Your device will now automatically connect to the MMU.

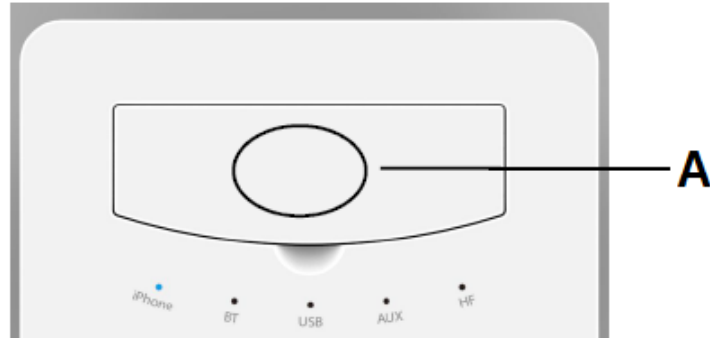

A

NFC

➤ Near Field Communication

i **INCOMING CALLS:** The hands-free function of your mobile phone is available in BLUETOOTH MODE. The call is transmitted through the speakers of the multimedia sound system. If necessary, you can switch off this function on your mobile phone.

PLAYING MUSIC USING A USB CONNECTION:

1. To play music using a USB connection, press the **-FUNC-** button **(2)** repeatedly until the USB-MODE indicator **(9)** lights up on the MMU.
2. Then select and connect the desired source option (USB stick, mobile phone with USB cable, etc.) to the MMU.



In USB MODE, you can charge your mobile phone using a USB cable.

NOTICE! In USB mode, only MP3 and WMA formats are supported.

PLAYING MUSIC USING AN AUX CONNECTION:

1. To play music using an AUX connection, press the **-FUNC-** button **(2)** repeatedly until the **AUX-MODE** indicator **(9)** lights up on the MMU.
2. Then select and connect the desired source option (AUX-capable device) to the MMU.

i The following formats / devices are supported in the **AUX MODE**:
MP3 / MP4, CD / DVD player, notebook, and PC.

18.6 Trouble shooting

PROBLEM	POSSIBLE CAUSE(S)
iPhone mode is on, but tracks are not played automatically.	<ul style="list-style-type: none"> ➤ Low iPod / iPhone battery. Charge battery.
No sound.	<ul style="list-style-type: none"> ➤ Volume is on minimum setting. ➤ Incorrect function setting. ➤ Incorrect cable connections. ➤ Change speakers if they are defective.
The MMU cannot be switched on.	<ul style="list-style-type: none"> ➤ The MMU is not plugged in properly. If the MMU is plugged in properly but you cannot operate it, please contact Gharieni Group GmbH.
The MMU does not work at all.	<ul style="list-style-type: none"> ➤ Unplug the MMU and then plug in again. ➤ iPod / iPhone are not plugged in properly.
Warning message.	<ul style="list-style-type: none"> ➤ The connected player is incompatible with the MMU. ➤ Check that your iPod / iPhone is genuine. ➤ Check that your iPod / iPhone is connected properly.

Control touch buttons do not work.	<ul style="list-style-type: none"> ➤ Do not press too hard. ➤ If a touch button no longer responds, the MMU must be replaced. <p>In this case, please contact our customer service.</p>
Bluetooth does not work.	<ul style="list-style-type: none"> ➤ Switch off all other devices paired with the Bluetooth appliance and scan for Bluetooth again. ➤ Do not pair any appliances placed behind a wall or in a corner. ➤ Keep a working distance radius of max. 8 m. ➤ The ID code of the MMU is 39X.
USB mode does not work.	<ul style="list-style-type: none"> ➤ Use music formats MP3 or WMA only. Any other formats cannot be played. ➤ Ensure proper condition of the USB connection (cable / stick etc.). ➤ Update your device.
AUX mode does not work	<ul style="list-style-type: none"> ➤ Ensure proper condition of the music source. ➤ Check proper condition and connection of the audio cable.

19. Initialization of the software

If you notice when recalling the memory positions you have stored that these bed positions are no longer reached, the software of the MLW must be re-initialized. To be able to reach the bed positions you have stored correctly again, the following steps must be carried out:

PLEASE PROCEED AS FOLLOWS:

1. All **drives** must be completely **retracted**, this means:
 - a. The actuator for height adjustment must be moved to the lowest position (**button A1** of the hand control / see below, fig. 15).
 - b. The actuator for the inclination (seat area / thigh area) must be level with the legrest (calf area), i.e. adjusted horizontally. **ATTENTION!** Please keep **button C1** of the hand control (see below, fig. 15) pressed **until the actuator switches off**
 - c. The actuator of the legrest must also be retracted, i.e. keep **button D1** of the hand control (see below, fig. 15) pressed **until the actuator also switches off audibly!**
- ❖ The initialization is complete when the described positions are reached.

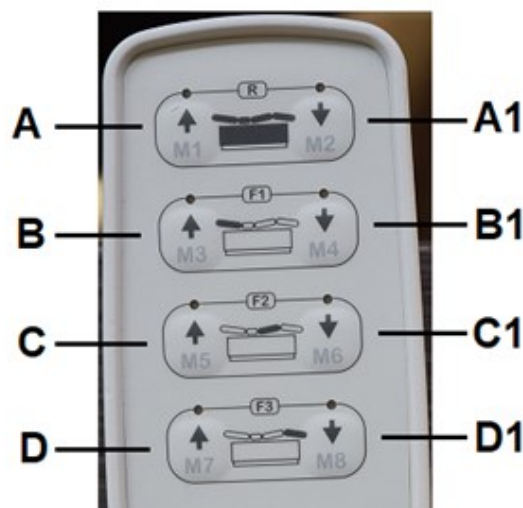

FIG. 15

- i** This adjustment (initialization) must be done manually, i.e. each drive must be moved individually. Do not use any of the memory buttons for this



Please make sure that you keep the buttons pressed for 2-3 seconds longer after reaching the end position.

⚠ WARNING! This adjustment (initialization) must be done manually, i.e. each drive must be moved individually. Do not use any of the memory buttons for this.

20. Reset

i You can reset the bed's software to its initial state; e.g. for complete re-programming of treatment positions, etc.

PLEASE PROCEED AS FOLLOWS:

1. Press the buttons **A** and **A1** (= reset / see below, fig. 16) of the **HAND CONTROL** simultaneously for approx. 5 seconds.
2. Several acoustic signals will sound, and the software will be reset to its initial state.

OR

1. Press pedals **L1** and **R2** of the **FOOT CONTROL** (see below, fig. 17) simultaneously for approx. 5 seconds.
2. Several acoustic signals will sound, and the software will be reset to its initial state.

i Stored memory positions are deleted!

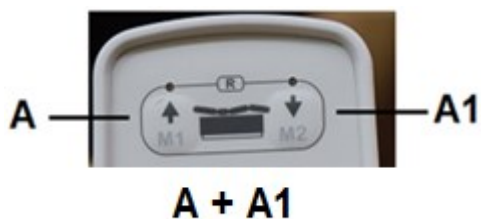

FIG. 16

OR

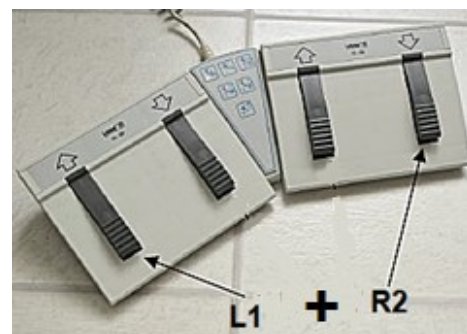

FIG. 17

21. Cleaning and maintenance

⚠ WARNING Always disconnect the MLW from the mains (unplug) before cleaning and maintenance. RISK OF ELECTRIC SHOCK!
RISK OF FIRE!

⚠ WARNING! Remove possible dust accumulation at the power plug, at the safety power socket and at all plug connectors **regularly**.
RISK OF FIRE!

⚠ WARNING! Always ensure that water or other liquids **cannot get** into the housing and the fittings of the MLE or into the hand control.
RISK OF ELECTRIC SHOCK! RISK OF FIRE!

- ❖ **Do not wear** any arm and finger decoration such as rings or bracelets while carrying out any cleaning or maintenance operations. Otherwise you can scratch and damage the upholstery and / or the material of the casing of the MLW unintentionally.
- ❖ Use water or a mild cleaning agent which is suitable for the material **only**.
- ❖ **Do not use** extremely hot water for cleaning of the MLW.
- ❖ **Do not use** any hard sponges, scouring pads or floor clothes.
- ❖ **Do not use** any aggressive cleaning agents such as scouring powders, floor cleaners, etc.
- ❖ **Do not use** any dishwashing detergents.
- ❖ **Do not use** any solvents or bleaching agents.
- ❖ **Do not use** any essential oils.

NOTICE! Damage to the upholstery and / or to the material of the casing caused using unsuitable cleaning agents **is not covered by the guarantee or the warranty!**

21.1 Cleaning and care of the upholstery

- ❖ The upholstery of the MLW F1 is equipped with an outer material made of polyurethane (PU).

21.1.1 Cleaning and care of the polyurethane (PU) material

- i** Clean the PU **only** with a soft cloth with a small amount of **a cleaning agent suitable for this material**, e.g. Mikrozyd Sensitive (also available from Gharieni: s. chapter 24. UPHOLSTERY CARE AND CLEANING AGENTS).

21.2 Cleaning of the housing and the fittings

- i** Clean the housing and the fittings only with a damp soft cloth or a soft sponge and some cleaning agent, e.g. with Mikrozyd Sensitive (s. chapter 24. UPHOLSTERY CARE AND CLEANING AGENTS).

⚠ WARNING! Always ensure that water or other liquids **never** penetrate the housing, the fittings, or the hand controls of the MLW. **RISK OF ELECTRIC SHOCK! RISK OF FIRE!**

21.3 Cover of the upholstery

- i** The upholstery surface of the MLW is made of PU (polyurethane).
- i** We recommend using suitable PROTECTIVE COVERS to keep the lying surface in good condition.
- i** See also chapter 23.4 PROTECTIVE COVERS.

PROTECTIVE COVERS AVAILABLE FROM GHARIENI GROUP GMBH:

For standard cosmetic applications (e.g. facials, etc.):	<ul style="list-style-type: none">➤ 5-piece terry cover➤ The 5-piece terry covers are available with or without oil-repellent PU coating
For massages including a small amount of oil:	<ul style="list-style-type: none">➤ These treatments require a protective cover made of PU; as the second outer skin of the MLW, so to speak.➤ It protects the upholstery from stains of oil and seeping in of oil.

22. Malfunctions (possible causes and troubleshooting)

MALFUNCTION	
POSSIBLE CAUSE(S)	TROUBLESHOOTING
ALL ACTUATORS DO NOT WORK.	
<ol style="list-style-type: none"> 1. No connection to the mains. 2. The power supply cable is damaged. 3. Hand control/ actuator plug is not plugged in properly. 4. Hand control is defective. 5. Foot control is defective. 6. Fuse is defective. 7. Control box total failure. 	<ol style="list-style-type: none"> 1. Check the connection status. 2. Power supply cable must be replaced (please contact the customer service). 3. Check proper connection of hand control / plug. 4. Hand control must be replaced (please contact the customer service). 5. Foot control must be replaced (please contact the customer service). 6. Fuse must be replaced (please contact the customer service). 7. Control box must be replaced (please contact the customer service).
SINGLE ACTUATOR DOES NOT WORK.	
<ol style="list-style-type: none"> 1. Actuator plug is not connected properly. 2. Hand control is defective. 3. Foot control is defective. 4. Control box is defective. 5. Actuator cable or plug is defective. 6. Actuator is defective. 	<ol style="list-style-type: none"> 1. Connect plug properly. 2. Hand control must be replaced (please contact the customer service). 3. Foot control must be replaced (please contact the customer service). 4. Control box must be replaced (please contact the customer service). 5. Cord / plug must be replaced (please contact the customer service). 6. Actuator must be replaced (please contact the customer service).

- i** If the Spa Table shows a malfunction other than those described above, or if you have checked all the items on the list but the problem could not be solved, please contact the customer service department (s. chapter 22.1 REPAIR OF THE MLW).

22.1. Repair

YOU CAN CONTACT THE GHARIENI CUSTOMER SERVICE USING THE FOLLOWING CONTACT INFORMATION:

CUSTOMER SERVICE HOTLINE:	+49 (0)2841/88300-40
E-MAIL:	service@gharieni.com

We are responsible for safety and reliability of the MLE under the following conditions **only**:

1. Always provide the **serial number** when contacting Gharieni customer service.
2. Repairs and modifications must be carried out by Gharieni Group GmbH or a person authorized by Gharieni Group GmbH.
3. If the electrical installation of the room the MLW is installed in, must meet the current legal regulations at the site where the MLW is operated.
4. If the MLW is operated as described in the instruction manual.
5. Unauthorized modifications or manipulating the MLW will void the liability of the manufacturer.
6. All electric components are designed for continuous operation.
Leave the MLW connected when it is used every day.
7. Check the power cord regularly for signs of damage.
8. If the power cable is damaged, it must be replaced by the manufacturer or an authorized aftersales service or a qualified professional only.



If you wish to contact the Gharieni customer service regarding your Spa Table, we recommend taking a photo of the rating plate beforehand (e.g. using a mobile phone or a digital camera). This makes it easier for you to identify the information of the rating plate (e.g. the serial number of the Spa Table) to provide the required information to the customer service.
On the cover page of this instruction manual is an empty area in which you can enter the serial number of your Spa Table. This way you always have the serial number at hand.

23. Optionally available accessories

- ★ For detailed information regarding the optionally available accessories (s. below) please contact our distribution department.
Our team is happy to help!

23.1 Gel cushions for nose slots

- ❖ GEL CUSHIONS for the headrest of the MLW are optionally available for an additional charge.
 - ❖ The GEL CUSHIONS are available in different variants.
 - ❖ The GEL CUSHIONS are perfectly suited for prone positions (massage positions).
 - ❖ Using a GEL CUSHION on the headrest upholstery (s. fig. below) can additionally support the face of the person to be treated.
 - ❖ Using a GEL CUSHION can also prevent your customers from getting uncomfortable pressure marks on the face.
 - ❖ Additionally, the face is cooled pleasantly due to the soft gel fluid.
- see also. chapter 10.6 HEADREST



GEL CUSHIONS FOR NOSE SLOTS

ITEM NUMBER: 45010

- ★ For detailed information regarding the **right size** and suitable version for your Spa Table please contact our distribution department.
Our team is happy to help!

23.2 Towels for nose slots (disposable cloths)

- ❖ DISPOSABLE CLOTHS (s. fig. below) for the nose slot of the headrest of the MLW are optionally available for an additional charge.
 - ❖ The DISPOSABLE CLOTHS are handy, hygienic, extra soft, and protect the upholstery of the headrest of your Spa Table.
 - ❖ We recommended the DISPOSABLE CLOTHS for **all** headrests which are equipped with a nose slot.
- i** The DISPOSABLE CLOTHS are available in different sizes; up to overlengths which can cover the entire width of the Spa Table incl. armrests.



- ★ For detailed information regarding the **right size** and suitable version for the headrest of your Spa Table please contact our distribution department. Our team is happy to help!

17.3 Neckrest “Dentalax”

- ❖ For the MLW, our popular NECK REST “DENTALAX” (s. fig below) is optional available for an additional charge.
- ❖ During treatment, this neck rest supports the cervical spine effectively.
- ❖ The NECK REST “DENTALAX” is available in white or in colour.
- ❖ The lying comfort will be increased significantly when using the NECK REST “DENTALAX”: “**SMALL PART, GREAT EFFECT!**”



(fig similar: colour and workmanship may vary depending on the model selected)

- ★ For detailed information regarding the right size and suitable version for the headrest of your Spa Table please contact our distribution department. Our team is happy to help!

23.4 Protective covers

23.4.1 Protective covers made of terry

- ❖ PROTECTIVE COVERS MADE OF TERRY for your Spa Table are optionally available for an additional charge.
- ❖ The PROTECTIVE COVERS MADE OF TERRY are available as a 5-piece set; with **or** without oil-repellent PU coating.
- ❖ The PROTECTIVE COVERS MADE OF TERRY are suitable for standard cosmetic applications.
- ❖ Our PROTECTIVE COVERS, which are specially manufactured for our Spa Tables, will perfectly protect your working equipment from dirt and heavy use.
- ❖ Machine laundry (max. 60 °C) for hygienic cleaning is possible due to the high-quality material.
- ❖ Internal elastic bands keep the single sections exactly in the right position. All functions of the Spa Tables will continue working.
- ❖ Our COVERS are available in three different colours: white / choco and crème.
- ❖ You can order the relevant cover when purchasing the Spa Table.



(fig. similar: fig. serves as an example **only**)

- ★ For detailed information regarding the right size and suitable version of the covers as well as the compatibility with your Spa Table please contact our distribution department. Our team is happy to help!

23.4.2 Protective covers made of PU

- ❖ PROTECTIVE COVERS MADE OF POLYURETHANE (PU) for Spa Tables (s. fig. below) are optional available for an additional charge.
- ❖ PROTECTIVE COVERS MADE OF PU serve the Spa Table as a second outer skin, so to speak.
- ❖ PROTECTIVE COVERS MADE OF PU are suitable for massages including a small amount of oil.
- ❖ The COVERS protect the upholstery of your Spa Table from stains of oil and seeping in of oil.
- ❖ Additionally, the covers are resilient, water- and oil-repellent, and washable up to 90 °C.



(fig. similar: fig. serves as an example **only**)

- ★ For detailed information regarding the right size and suitable version of the covers as well as the compatibility with your Spa Table please contact our distribution department. Our team is happy to help!

23.4.3 Protective foot cover

- ❖ A PROTECTIVE FOOT COVER (s. fig. below) for Spa Tables is optionally available for an additional charge.
- ❖ The PROTECTIVE FOOT COVER is made of stable, transparent plastic and is attached with Velcro / counter Velcro.
- ❖ The COVER protects the foot section of your Spa Table from dirt and soiling (e.g. by shoes).



PROTECTIVE FOOT COVER

ARTICLE NUMBER: 49052

NOTICE! We recommend that you order the foot - protective cover **directly with the purchase of your spa table**. In this case, the counter Velcro is already attached to the spa table on delivery so that you can attach the foot cover easily and comfortably. If you order the foot cover later, you must **attach the counter Velcro** to the spa table **yourself**.

- i** If you would like to order a protective foot cover for your Spa Table later, please indicate during the ordering process that the **Counter Velcro strip should be included**.

24. Upholstery care and cleaning agents

24.1 mikroqid[®] sensitive (alcohol-free)

- ❖ We recommend mikroqid[®] sensitive for gentle and thorough care and cleaning of the upholstery.
- ❖ mikroqid[®] sensitive removes bacteria, fungi, and viruses (e.g. HBV, Rota, Vaccinia etc.).
- ❖ mikroqid[®] sensitive is available as liquid.
- ❖ **Suitable for cleaning of PU and artificial leather upholstery.**
- ❖ **Without alcohol!**



MIKROZID[®] SENSITIVE LIQUID

ITEM NUMBER: 79417

Microbiological efficacy

Efficacy	Concentration	Contact time
bactericidal <i>in accordance with VAH Guidelines with short contact times</i>	ready-to-use	1 min.
MRSA	ready-to-use	1 min.
levurocidal <i>in accordance with VAH Guidelines with short contact times</i>	ready-to-use	1 min.
virucidal against enveloped viruses <i>in accordance with DVV (German Registered Association for Combating Viral Diseases)//RKI Guideline</i>	ready-to-use	1 min.
Norovirus EN14476	ready-to-use	15 min.
Polyoma SV40	ready-to-use	1 min.
Rotavirus	ready-to-use	1 min.

Certificates

- VAH certificate
- IHO listed



CE 0297

24.2 Skai cleaner

- ❖ For gentle and thorough care and cleaning of the artificial leather upholstery we additionally recommend Skai cleaner.
- ❖ Skai cleaner is available in a 200 ml spray bottle.
- ❖ **Especially suitable for cleaning artificial leather.**



SKAI CLEANER

ITEM NUMBER: 79427

25. Conditions for transport, storage, and operation

25.1 Transport (with castors / without castors)

- ❖ On **flat surfaces**, the MLW can be moved or transported using its castors (s. chapter 6.2.2 EXTENDABLE / RETRACTABLE CASTORS).
- ❖ On **uneven surfaces**, you **must not use** the castors of the MLW. In this case, lift the MLE during transport using the **carrying aids only** (s. chapter 6.2.1 USE OF THE CARRYING AIDS).
- ❖ **Never** lift the MLW at its lying / sitting surface or its armrests during transport; otherwise you can damage the MLW seriously.
- ❖ Always consider the total weight of the MLW. The total weight is approx. 125 kg; so, you may need the help of several persons.
- ❖ **Always** consider the dimensions of the MLW. Narrow hallways, doors or staircases can make transport difficult or impossible.

25.2 Ambient conditions for storage and transport

Temperature	from -10 °C to +50 °C (ambient temperature)
Atmospheric pressure	from 700 to 1060 hPa
Relative humidity	from 20% to 90% at +30 °C non-condensing

25.3 Ambient conditions for operation

Temperature	from +5 °C to +40 °C (ambient temperature)
Atmospheric pressure	from 700 to 1060 hPa
Relative humidity	from 30% to 75% at +30 °C non-condensing

26. Technical Data

MLW F1 / GENERAL TECHNICAL DATA	
Total length	203 cm
Total width Small	76 cm
Total width Medium	85 cm
Total width Large	92 cm
Height adjustment range MLW F1 WOOD	approx. 58 cm - 91 cm
Height adjustment range MLW F1 SOFT	approx. 63 cm - 96 cm
Inclination of the headrest	approx. +30° / -30°
Inclination of the backrest	approx. 0° - 75°
Inclination of the legrest	approx. 0° - 25°
Lifting capacity	250 kg
max. load of the lying surface	300 kg
max. load of the armrests	25 kg
Total weight (without options)	approx. 125 kg
A-sound pressure L_{PA}	≤ 35 dB(A)

❖ Subject to technical changes

MLW F1 / DRIVES INCL. CONTROLS	
Power supply	230 V AC/50-60 Hz/3A
Power consumption	approx. 200 Watt (VA) max
Output voltage	24 V DC
Duty cycle (drive)	10 % max. 2 Min. continuous operation/ 18 min. pause
Hand control	coiled cable
Device protection class	I with Smart Thermo and / or Vibro Wellness 10; otherwise II
Protection class against electric shock	Type B
Protection class against penetration of substances	IP X4

❖ Subject to technical changes

TRIPLE AIRBACK / TECHNICAL DATA

Power supply 230 V AC/48-60 Hz
Power consumption approx.120 Watt (VA) max.
Fuse: 630mA-T

Variant: 115V AC/48-60 Hz
Power consumption approx.120 Watt (VA) max.
Fuse: 1,6A-T

Transformer output voltage 12 V AC / approx. 9A max.

❖ Subject to technical changes

VIBRO WELLNESS 10 / TECHNICAL DATA

Power supply 100-240 V AC/50-60 Hz
Power consumption 20 Watt (VA) max.

Transformer output voltage 15 V DC / 1,3 A / 19,5 Watt (VA)
A-sound pressure L_{PA} ≤ 54 dB(A)

❖ Subject to technical changes

SMART THERMO HEATING SYSTEM / TECHNICAL DATA

Power supply 230 V AC/48-60 Hz
Power consumption approx.120 Watt (VA) max.
Fuse: 630mA-T

Variant: 115V AC/48-60 Hz
Power consumption: approx.120 Watt (VA)max.
Fuse: 1,6A-T

Transformer output voltage 12 V AC / ca. 9A max.

❖ Subject to technical changes

27. Disposal

1. While unpacking, the packaging materials (polyethylene bags, polystyrene pieces, etc.) should be kept away from children and pets. **CHOKING HAZARD! RISK OF INJURY!**
2. Do not dispose of the MLW together with your domestic waste. Old and unused Spa Tables must be sent for disposal to the responsible recycling centre for electric appliances. Do not remove the relevant symbol from the product.
3. **Never** expose to open flames.
4. The Spa Table should be cleaned thoroughly before disposal to protect persons, environment, and materials.
5. Before you dispose of a Spa Table or any old appliance, **render it inoperative**. Unplug the Spa Table / appliance and cut off the entire power cord. Dispose of the power cord and the plug immediately.
6. The MLW is made of metal and plastic components, electronic components, electric cables. Dispose of the separate components in accordance with the current local disposal regulations.
7. Dispose of any paper and cardboard into the corresponding containers.
8. Dispose of any plastics into the corresponding containers
9. If suitable containers are not available at your residential area, dispose of these materials at a suitable municipal collection point for waste-recycling.
10. Receive more detailed information from your retailer, municipal facilities or:

Gharieni Group GmbH

➤ Phone:	+49 (0)2841/88300-0
➤ Fax:	+49 (0)2841/88300-999
➤ Customer service:	+49 (0)2841/88300-40
➤ E-mail:	service@gharieni.com



Materials marked with this symbol are recyclable.



You can obtain all available information on waste separation from your local authorities.

28. Warranty provisions

The following warranty conditions apply to new goods worldwide:

Gharieni Group GmbH grants on all spa tables of the MLW F1 series:

- 10 years warranty on metal frames,
- 5 years warranty on actuators and
- 3 years warranty on other components.

28.1 Warranty exclusions



On delivery, it must be checked that there is no transport damage and that the accessories are complete and in proper condition. Resulting warranty claims must be registered within 8 days after delivery of the Gharieni product.

Excluded from warranty are wearing parts (such as all kinds of lamps as well as glass panels, consumables such as terry towels etc.).

Furthermore no warranty claims will be granted if:

- the spa table and its associated components have been damaged due to improper use.
- damage to the spa table and its associated components has been caused by gross negligence.
- the malfunction occurs through the fault of the operator.
- stickers (such as rating plate, warning notices etc.) have been removed.
- associated equipment or parts of the spa table or the associated equipment are opened without this being expressly permitted in the instruction manual (e.g. for cleaning purposes).
- the instructions in this instruction manual have not been followed.
- the spa table shows changes due to repair work by personnel not authorized by Gharieni Group GmbH.

29. EC-Declaration Of Conformity

<p>EC-Declaration of Conformity</p> <p>We,</p> <p>Gharieni Group GmbH Gutenbergstraße 40 47443 Moers / Germany</p> <p>hereby declare, in sole responsibility, that, due to its design and construction, the device named below complies with the relevant, fundamental safety and health requirements of the EU.</p>		
(Type or model, name)		
	<p>Scissor-type lifting beds Model: MLW-F1; MLW NEO; MO1; Relax; MLW Transform, MLE</p>	<p>2020</p>
<p>Relevant EU directives and harmonized standards used:</p> <p>2006 / 42 / EU Machinery directive</p> <p>2014 / 35 / EU Low voltage directive</p> <p>2014 / 30 / EU Electromagnetic compatibility directive</p> <p>2011 / 65 / EU ROHS directive</p> <p>DIN EN ISO 12100 (2011) Safety of machinery - general principles for design Risk assessment and risk reduction</p> <p>EN 55014-1 (05/2012) EN 55014-2 (01/2016) EN 61000-3-2 (03/2014) EN 61000-3-3 (03/2014)</p> <p>EN 61000-4-2 (12/2009) EN 61000-4-3 (04/2011) EN 61000-4-4 (04/2013) EN 61000-4-5 (03/2019) EN 61000-4-6 (08/2014)</p> <p>EN 61000-4-11 (06/2019)</p>		
<p>Responsible for documents:</p> <p>Mohammad Abbassi Gutenbergstraße 40 D-47443 Moers</p>	<p>Manufacturer's signature:</p> <p>Sammy Gharieni, CEO</p> 	<p>Place and date:</p> <p>Moers, 28.10.2020</p>

30. Status of edition

EDITION	ALTERATIONS (PAGES)	DATE
First edition	-	March 2011
Second edition	- Addition of technical data - update of the Declaration of Conformity - various photos updated	March 2019
Third edition	- Specification of sound pressure level - update of the Declaration of Conformity	July 2019
Fourth edition	complete revision	May 2021



NOTES

THE OWNERSHIP RIGHTS TO THIS INSTRUCTION MANUAL ARE RESERVED. REPRODUCTION OR TRANSFER TO THIRD PARTIES IS PROHIBITED WITHOUT THE CONSENT OF GHARIENI GROUP GMBH. GHARIENI GROUP GMBH RESERVES THE RIGHT TO PROTECT ITS PROPERTY RIGHTS AND TO PROSECUTE ANY MISUSE.

DISTRIBUTION AND SHOWROOM	PRODUCTION, PICK-UP AND REPAIR
Gharieni Group GmbH Gutenbergstraße 40 47443 Moers / Germany	Gharieni Group GmbH Am Schürmannshütt 24 47441 Moers / Germany